

(1, 1)

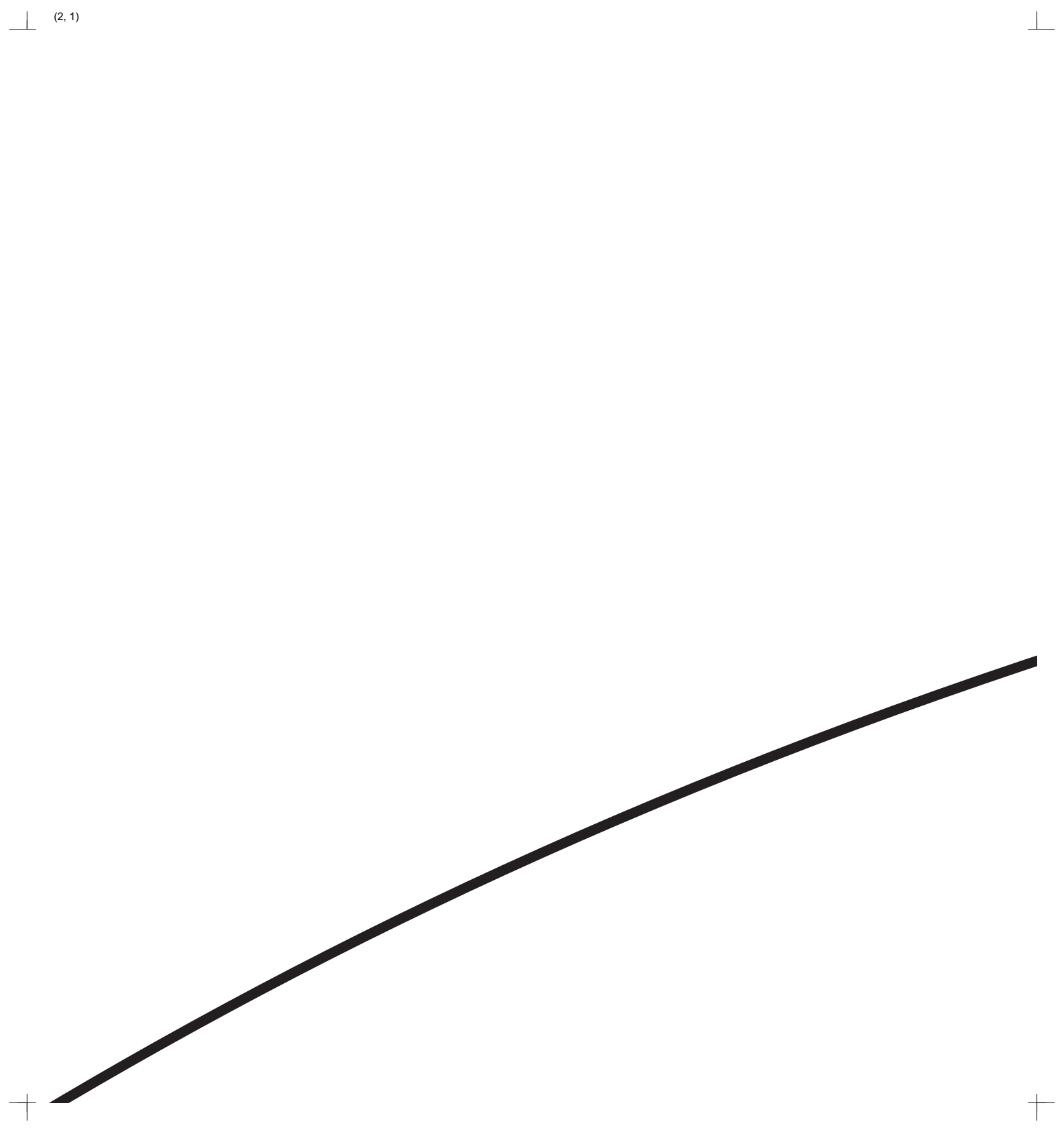



⊥ (3, 1)

⊥



+

+

⊥ (4, 1)

⊥

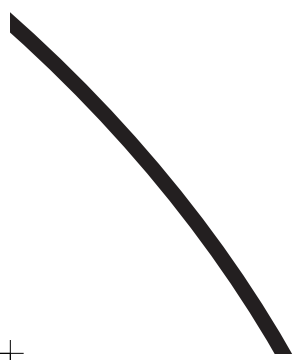

+

+



inner

(6, 1)

L

es Beinteil (

(7, 1)

unten)

(8, 1)





(9, 1)

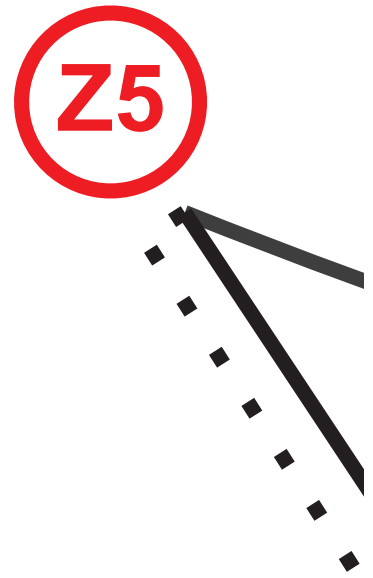

(10, 1)

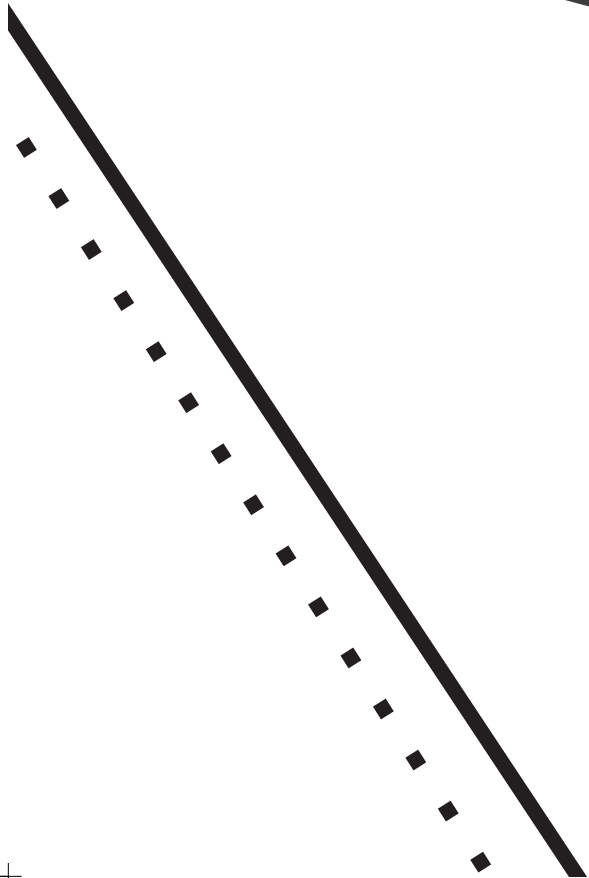
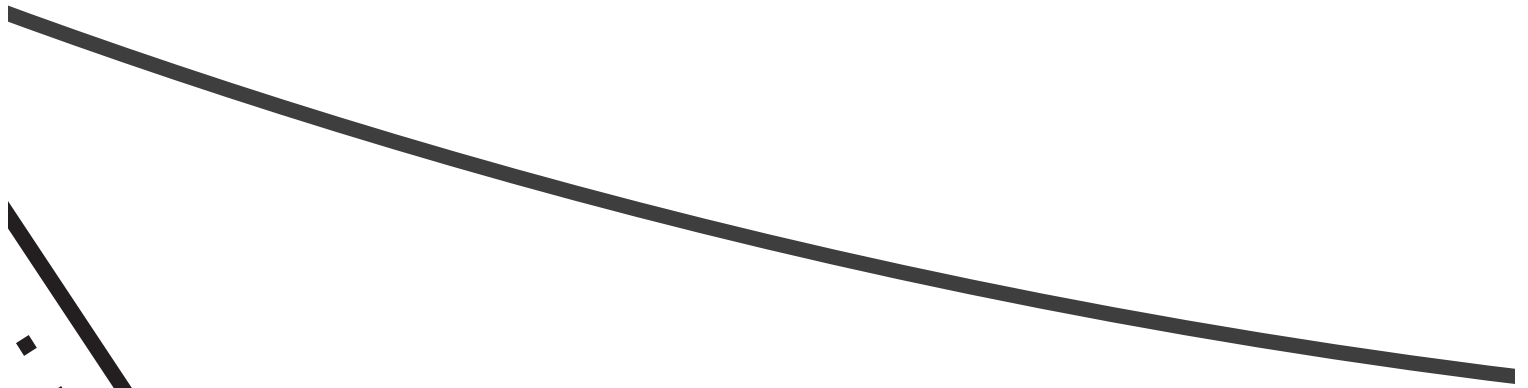

2  $\Sigma$

(11, 1)

Oberseite

z seitlicher Kiefer

(12, 1)

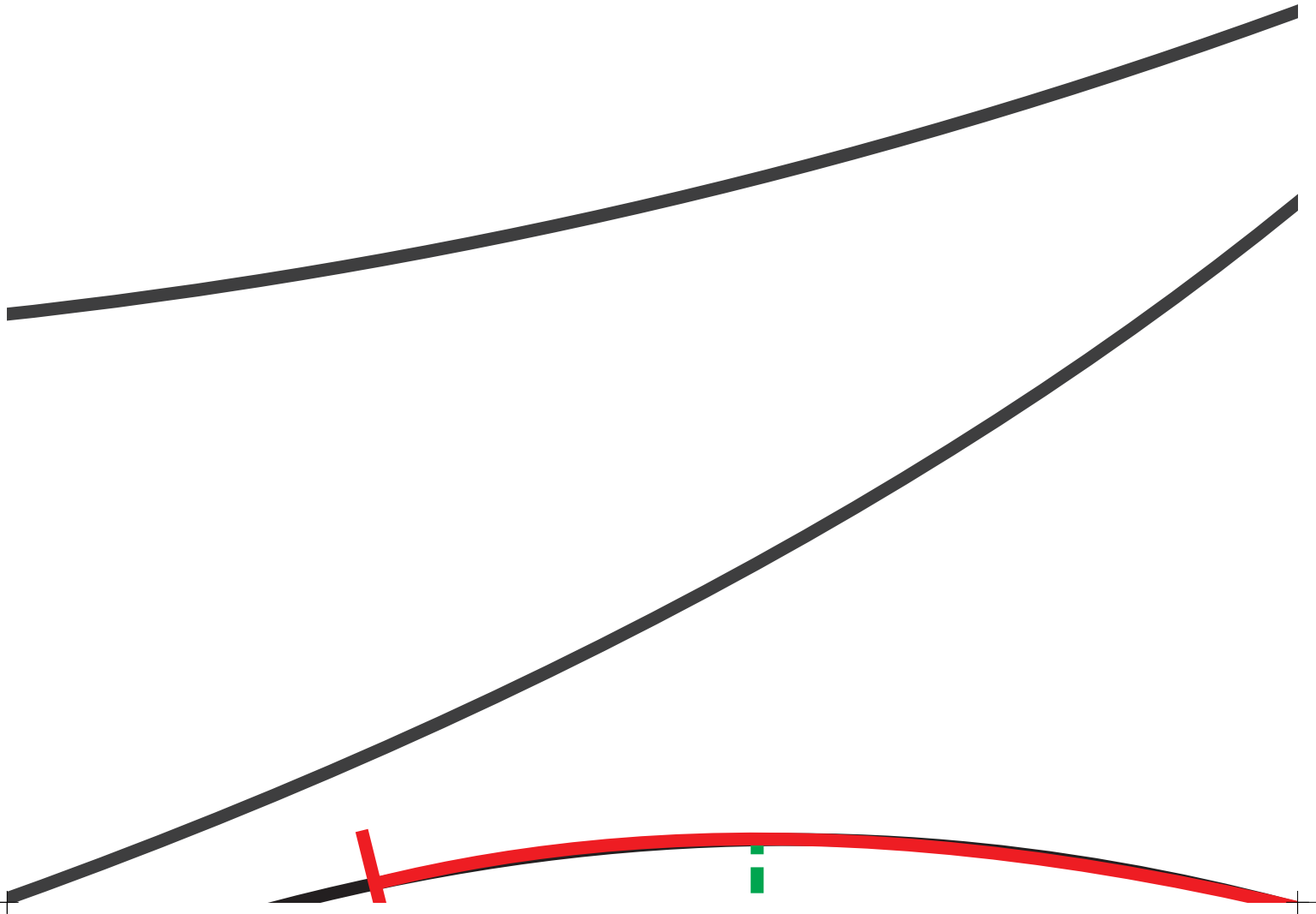



**Z6**



Augent  
8x

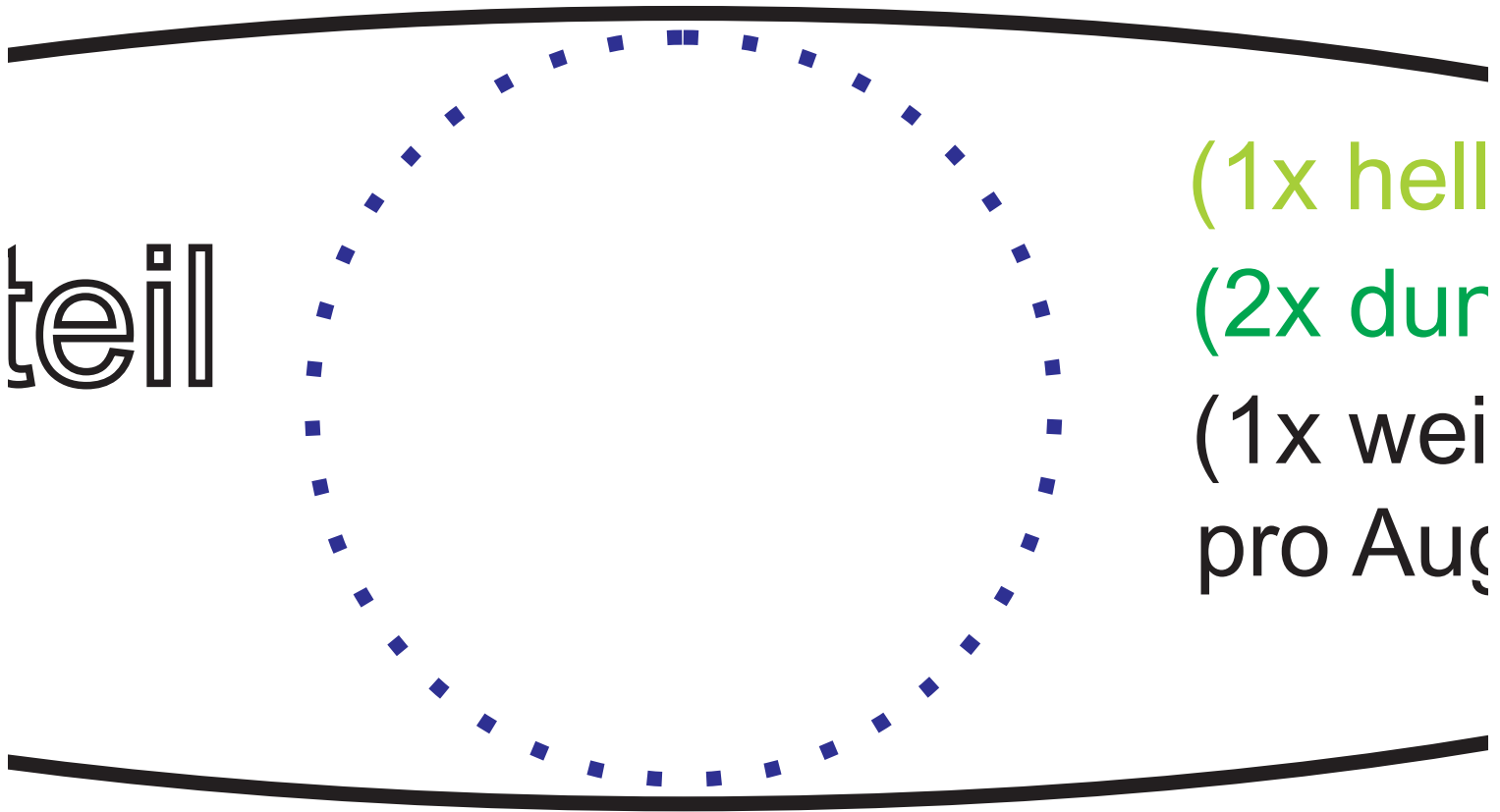

teil

(1x hell  
(2x dur  
(1x wei  
pro Aug



grün)

ikelgrün)

ss + Pupille)

ge

Pupille  
2x blau

# obere Zähne Seite weis

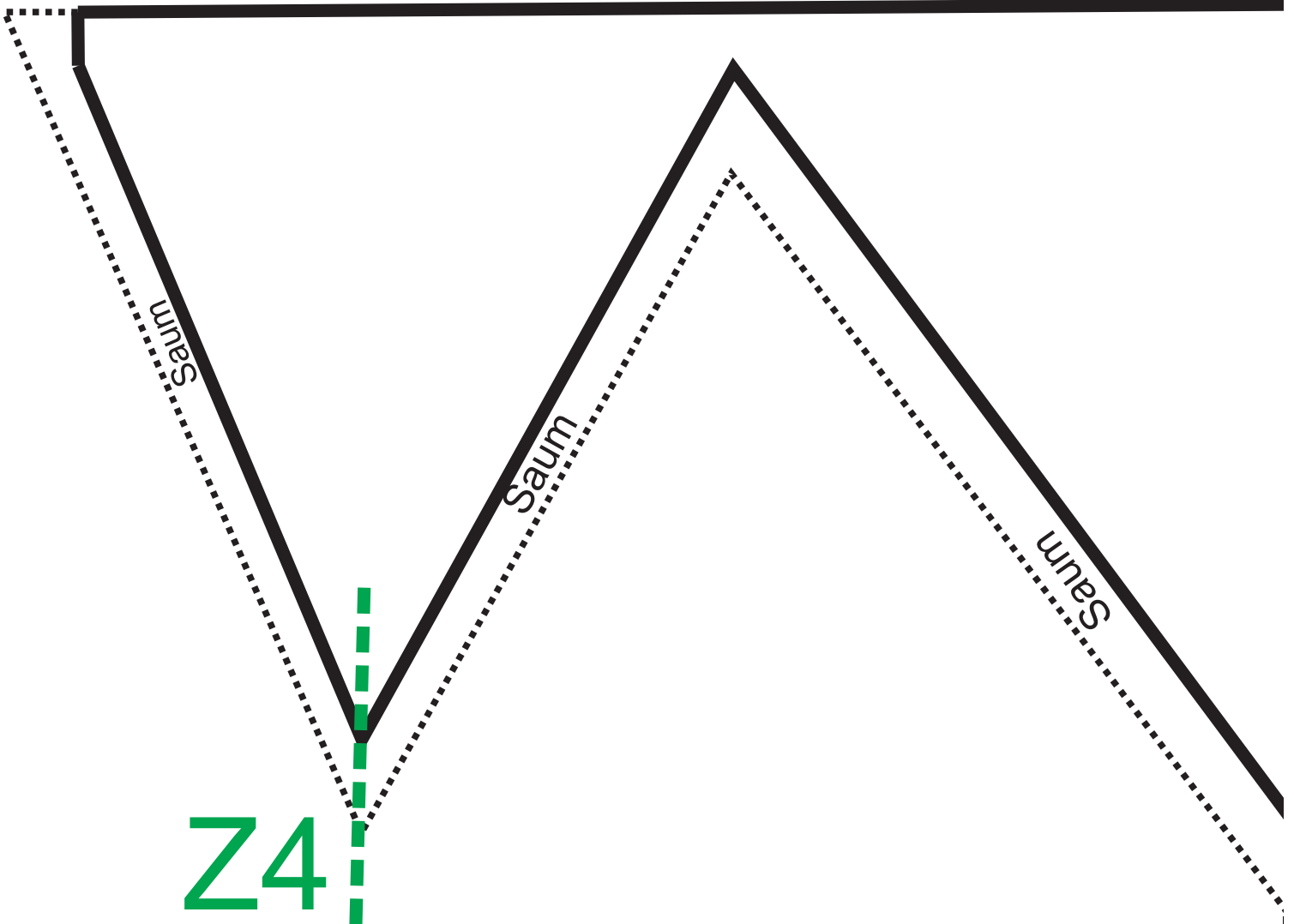



SS 2x

Z2



Z2

Zährl

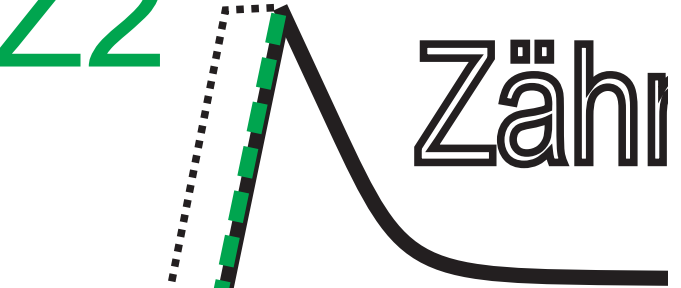

Z1

Saum

Saum

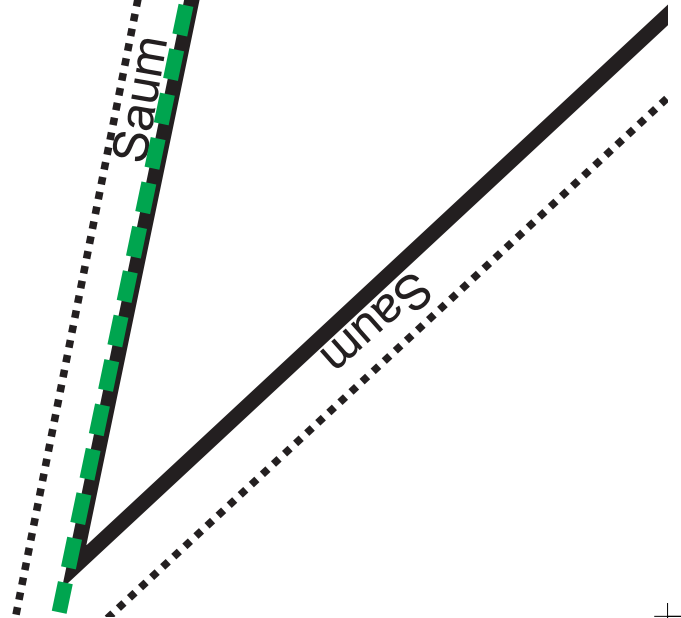

ne oben vorn weiss 1x

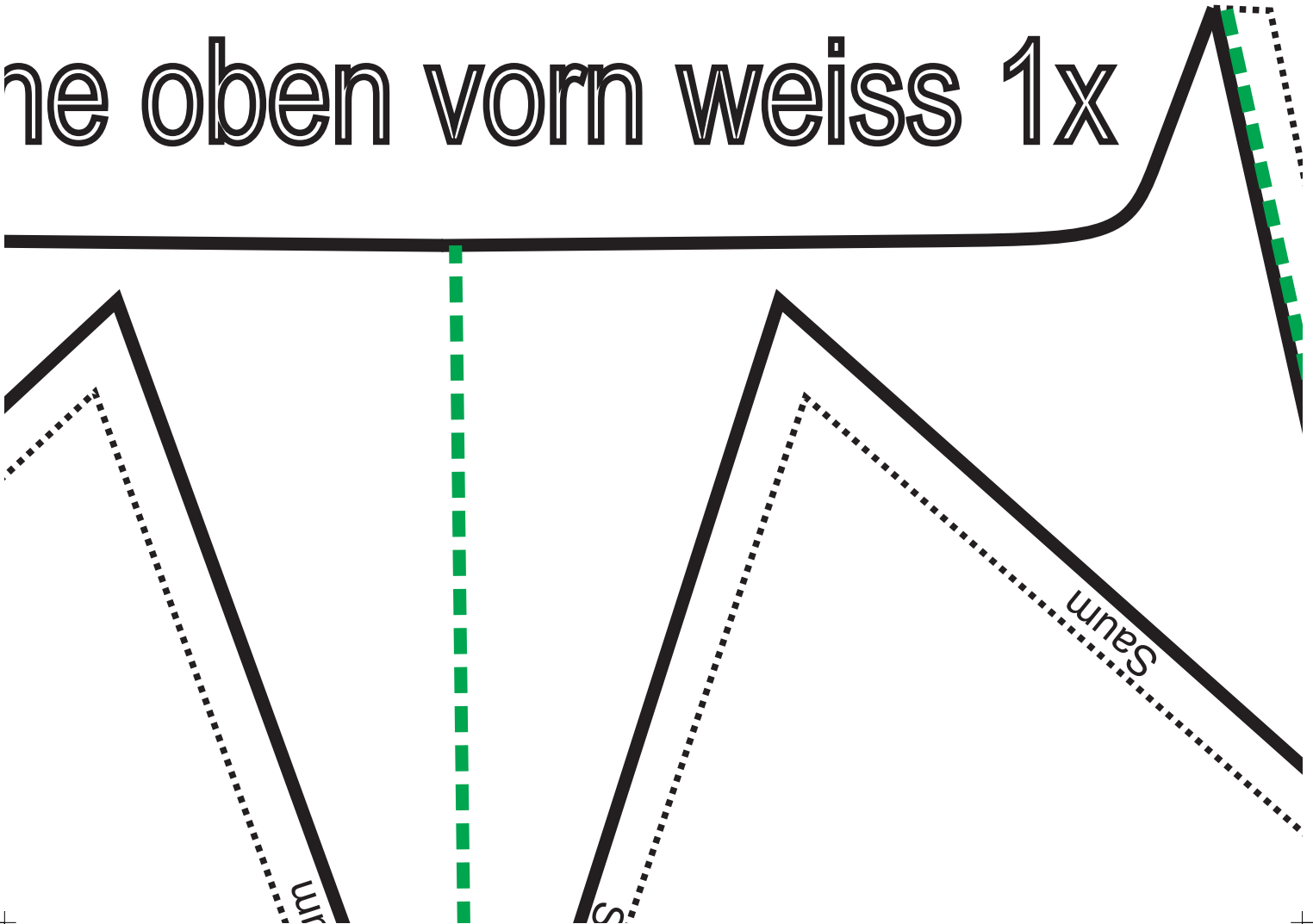

Z2

Z1

Z1

same

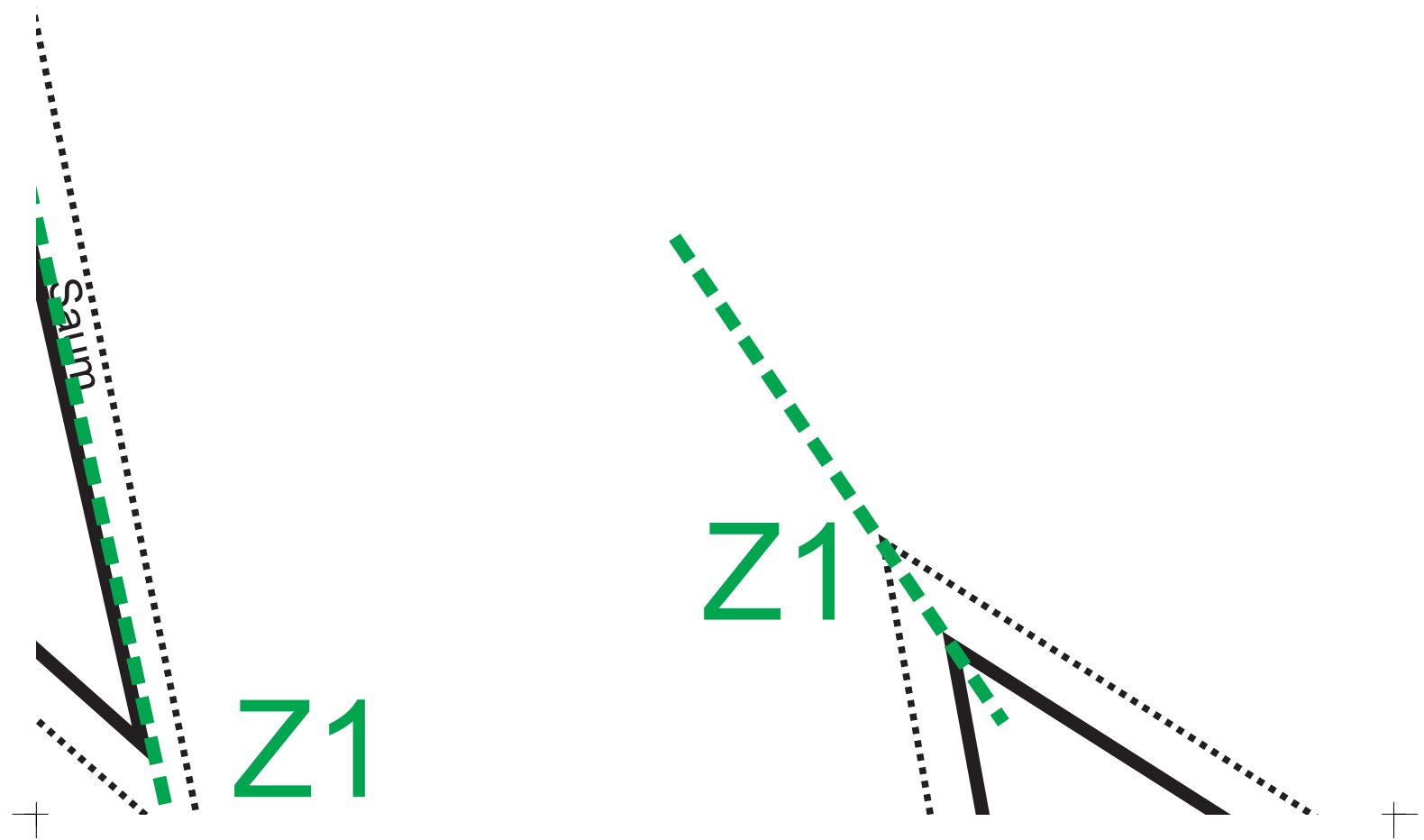

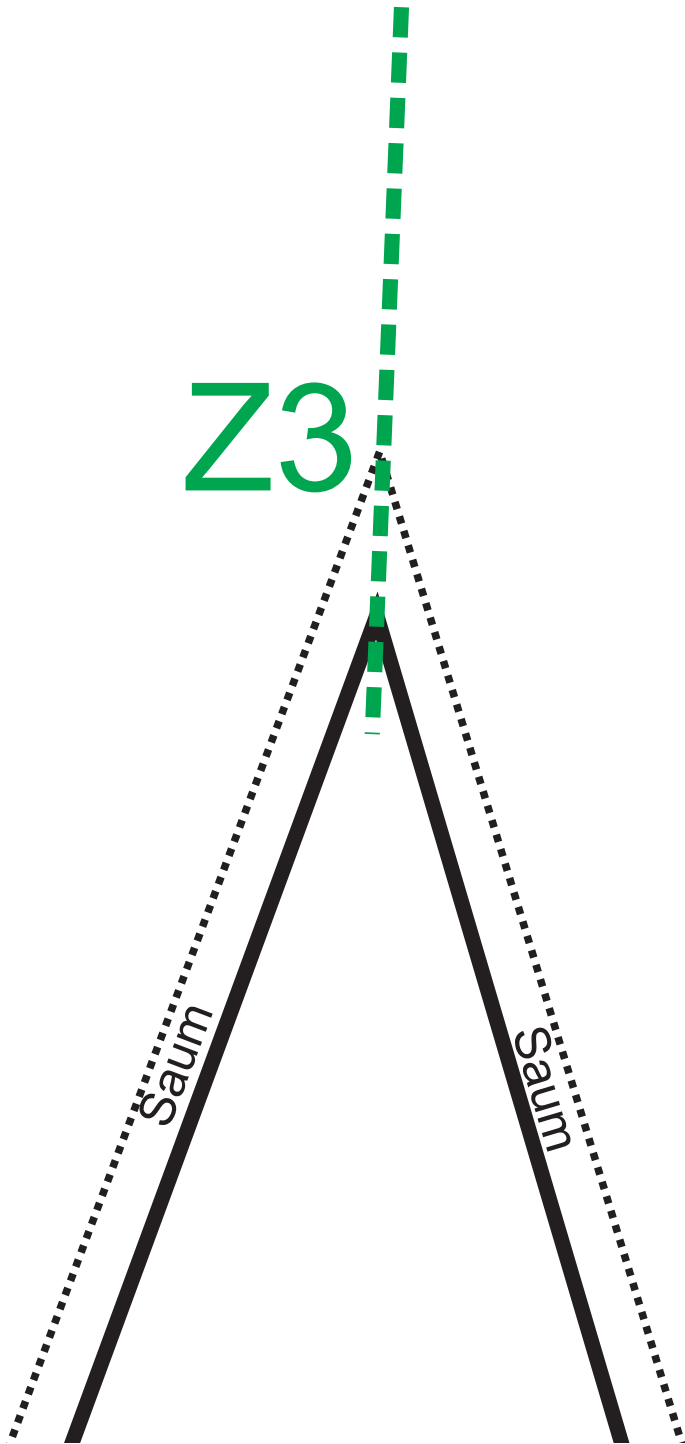

Saum

(21, 1)

$z_1$



---

1x Pacl

---

ksack 50x35

┌ (24, 1)

┌

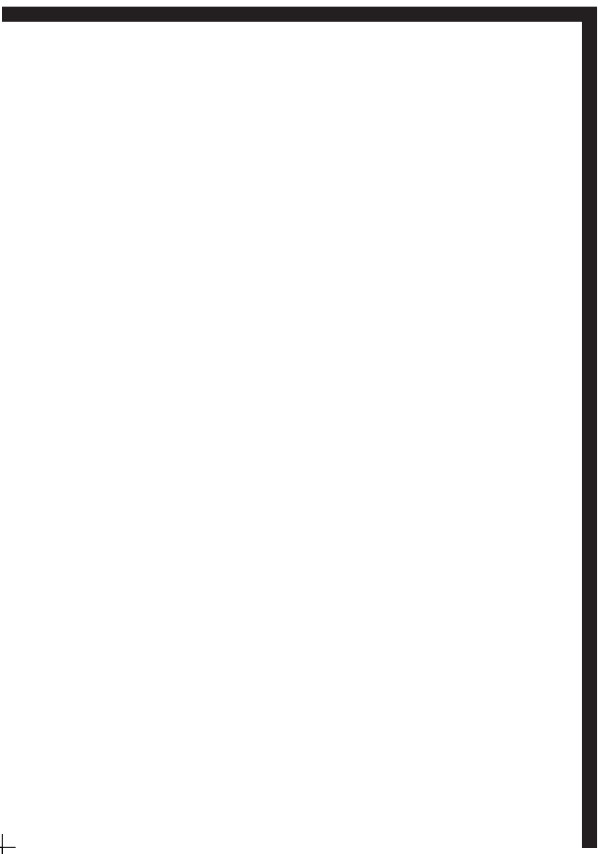

+

┌





(F)



Beinöffnung 30 cm



äußeres |  
dunkelgr

# Beintteil ün 4x

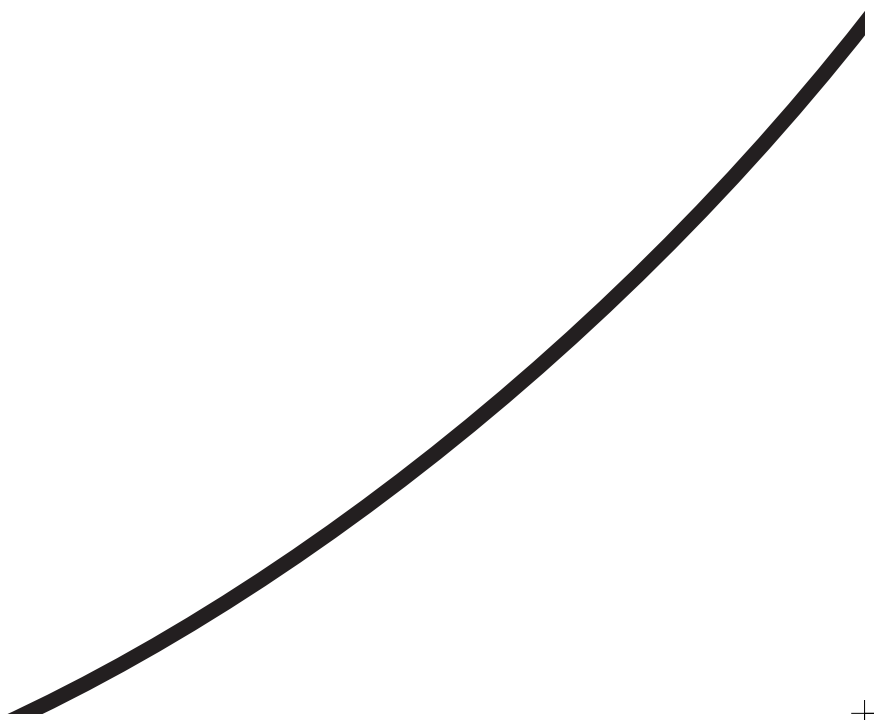

(4, 2)



# hellig!

**I**

Waage vorn

**B**

**1**  
Lifteraufhängung

rün 4x



(7, 2)

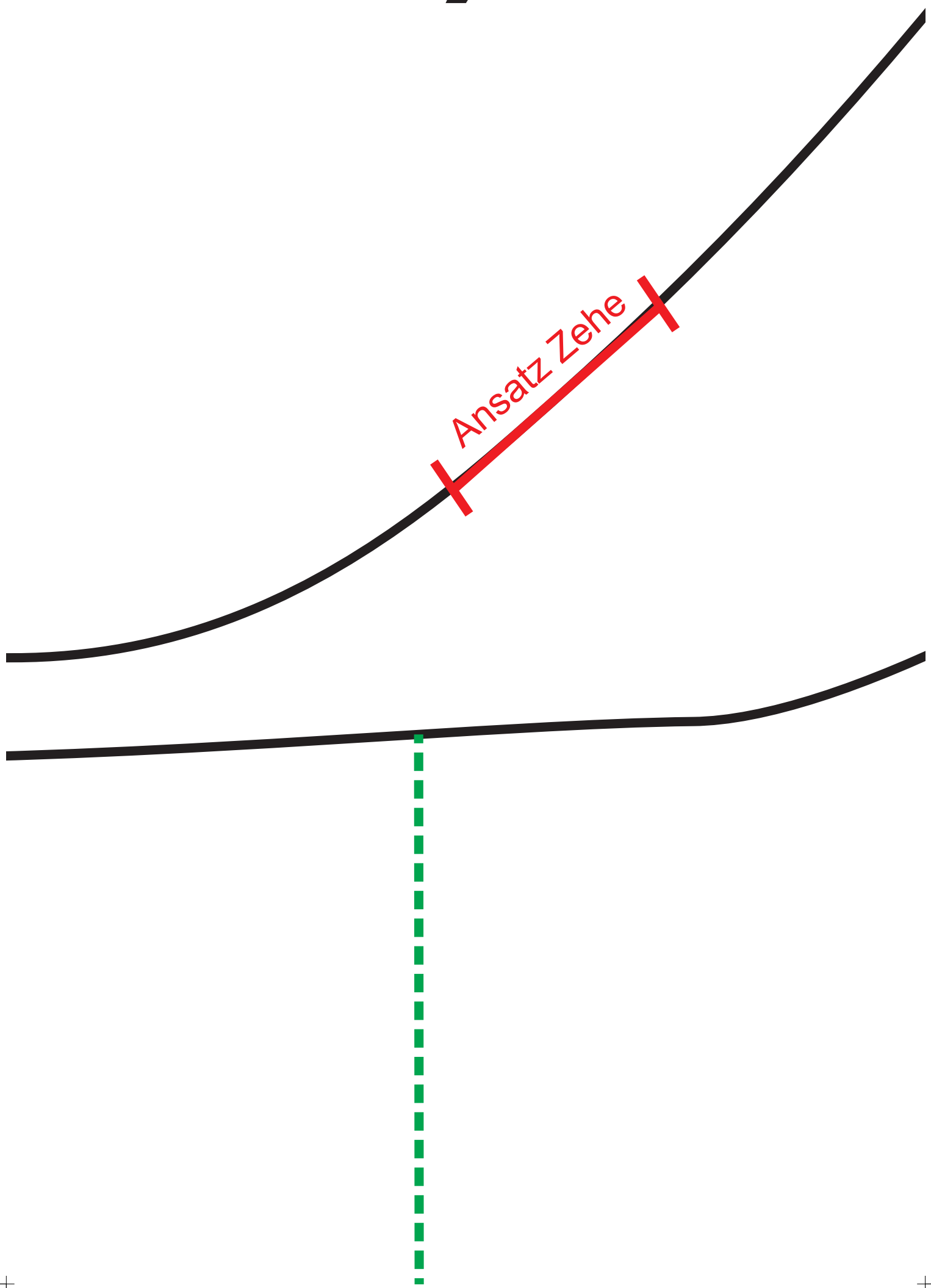

Ansatz Zehe

(8, 2)

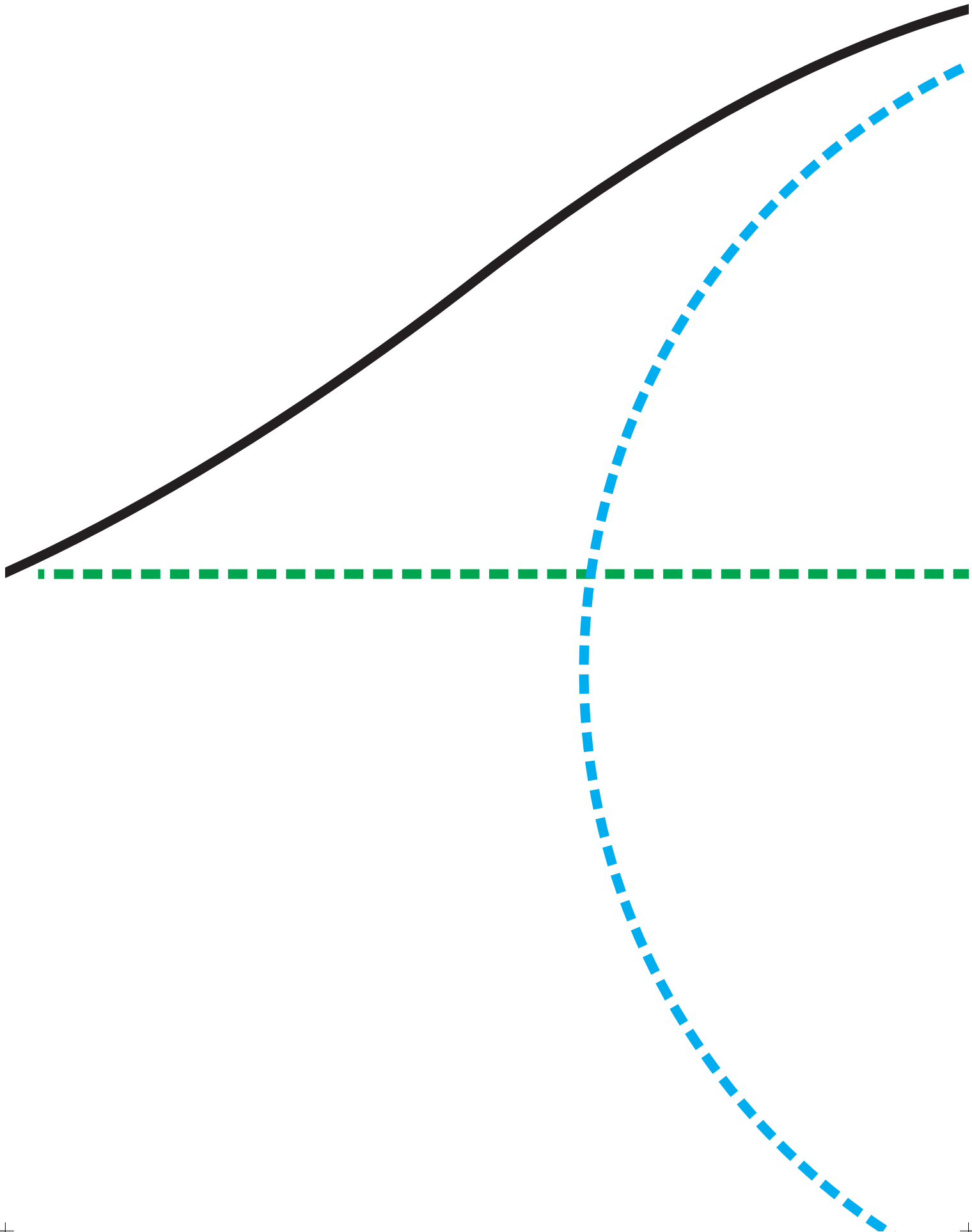



Umfang 87 cm

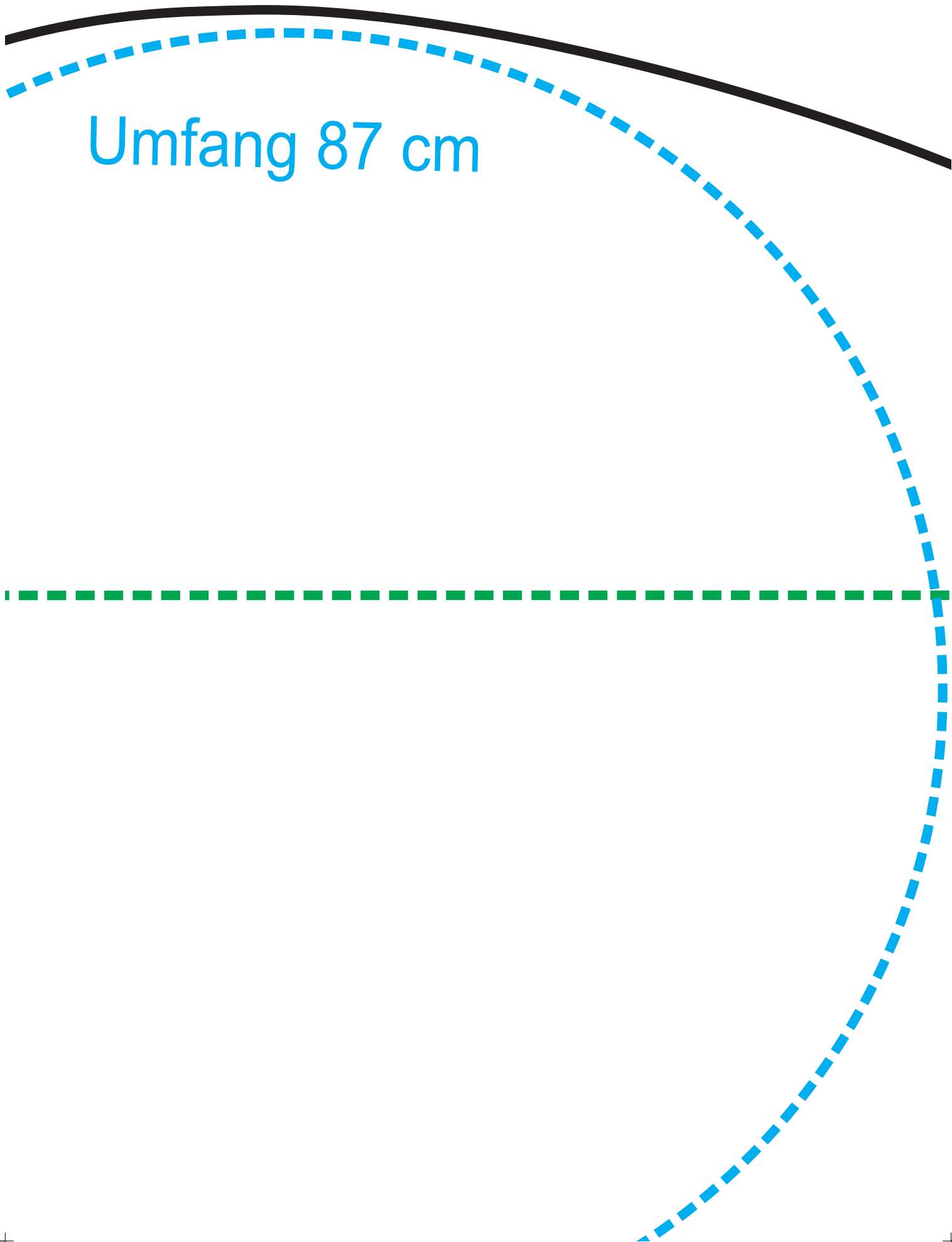

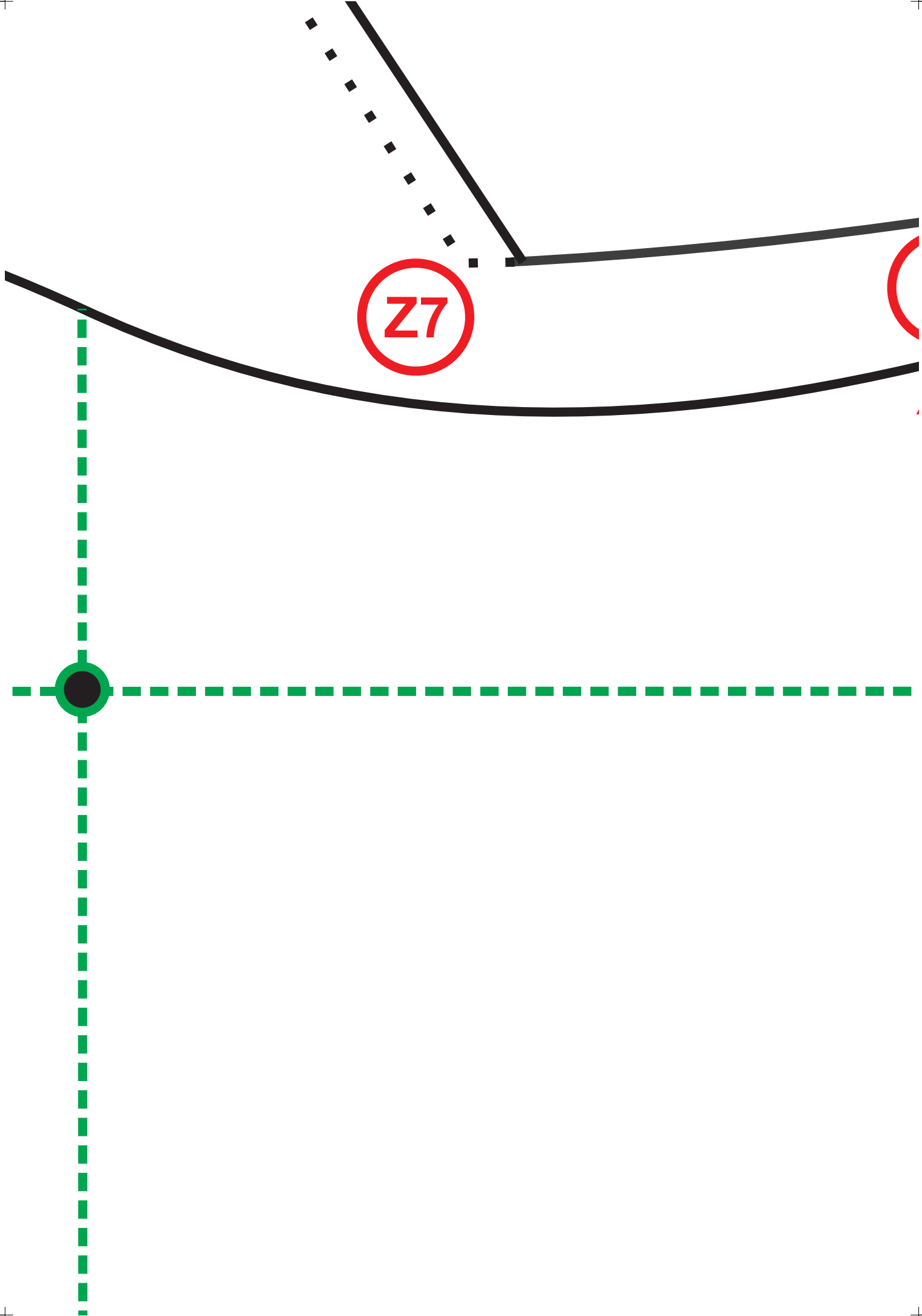

Unterseite

A



(12, 2)



# Zacken einnähen (I)

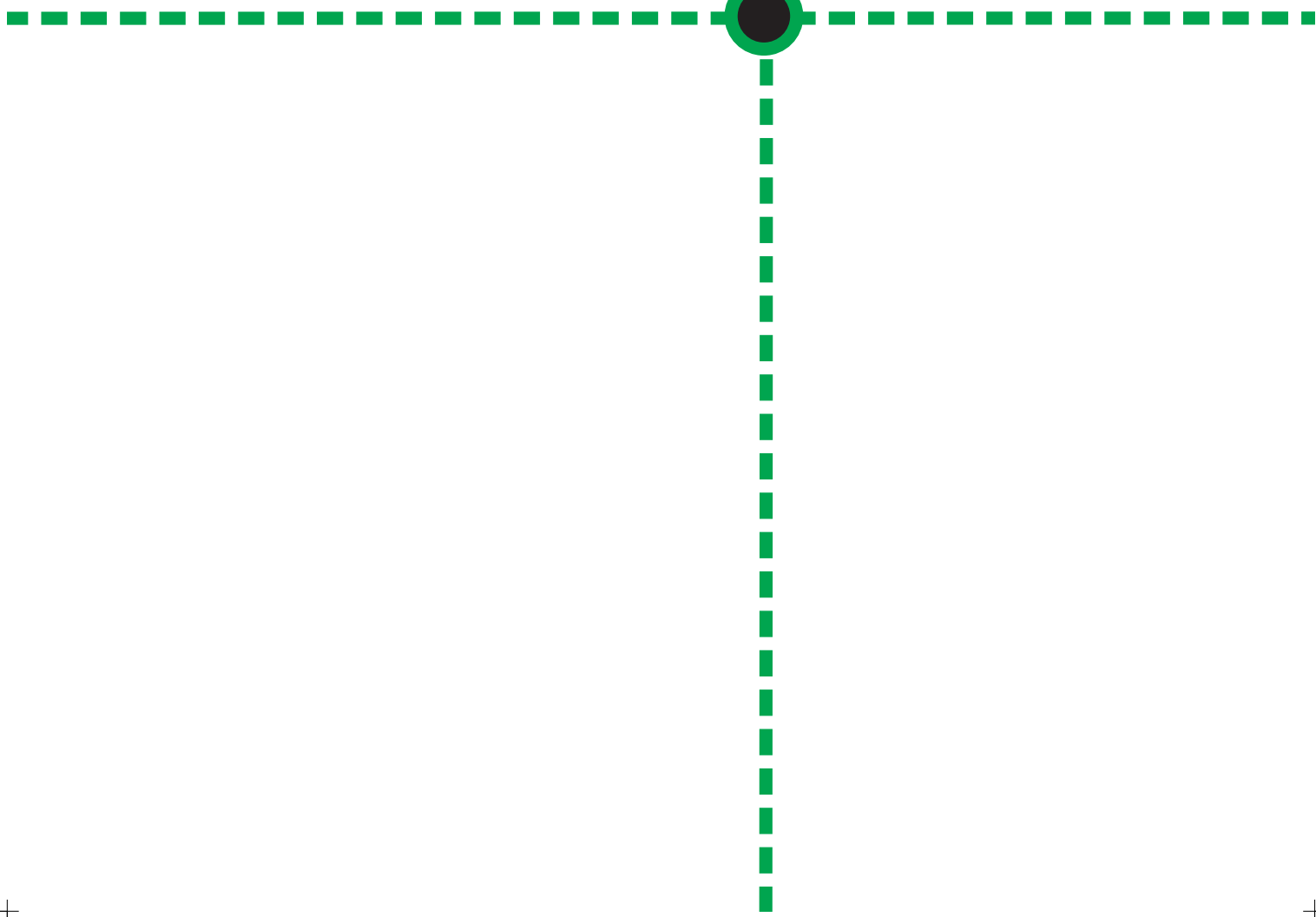

(13, 2)



Vr. 1)

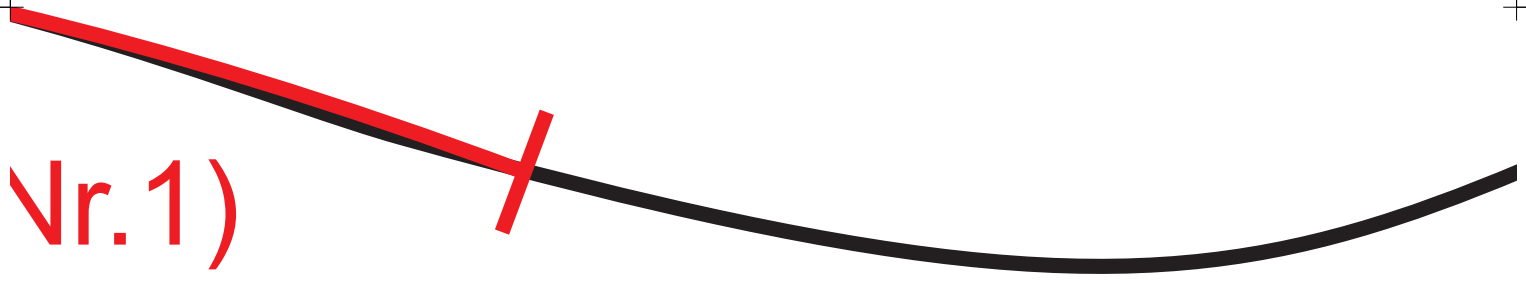

(14, 2)

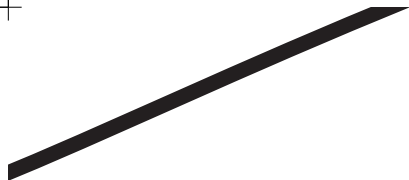

Zacken



(15, 2)

einnähen (Nr.2)

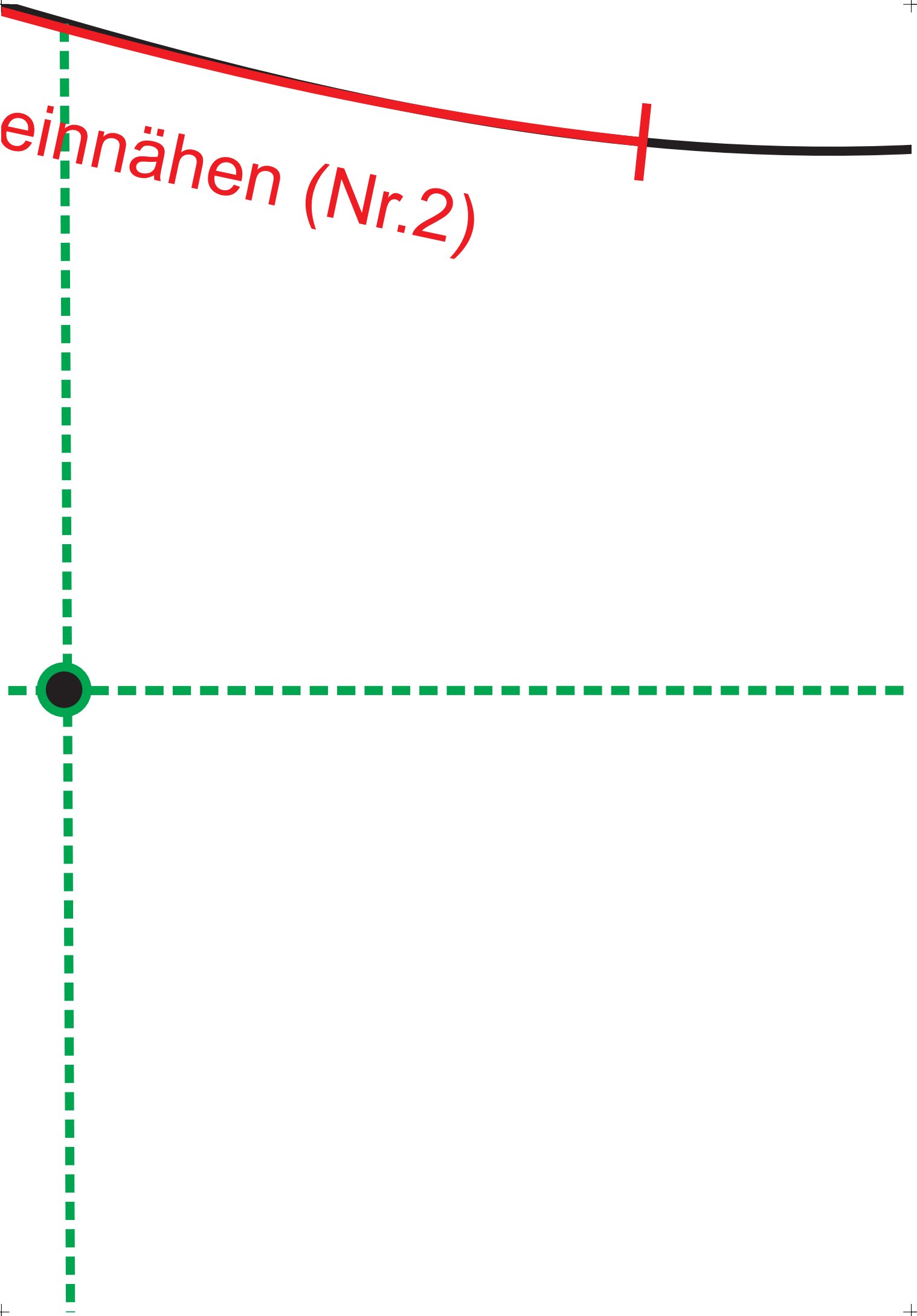

(16, 2)





(17, 2)

$\sqrt{z_1}$

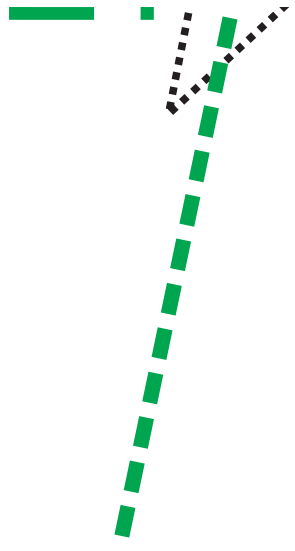

Zacken einnähen (Nr. 3)



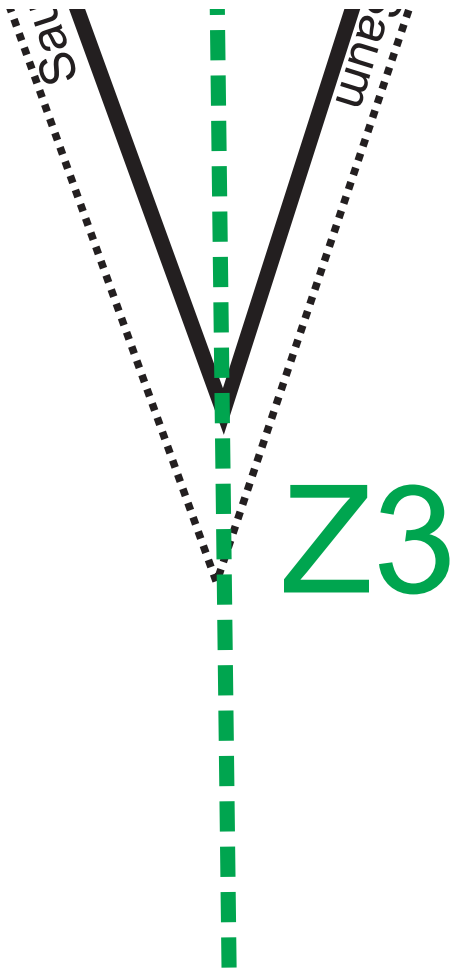

Z3

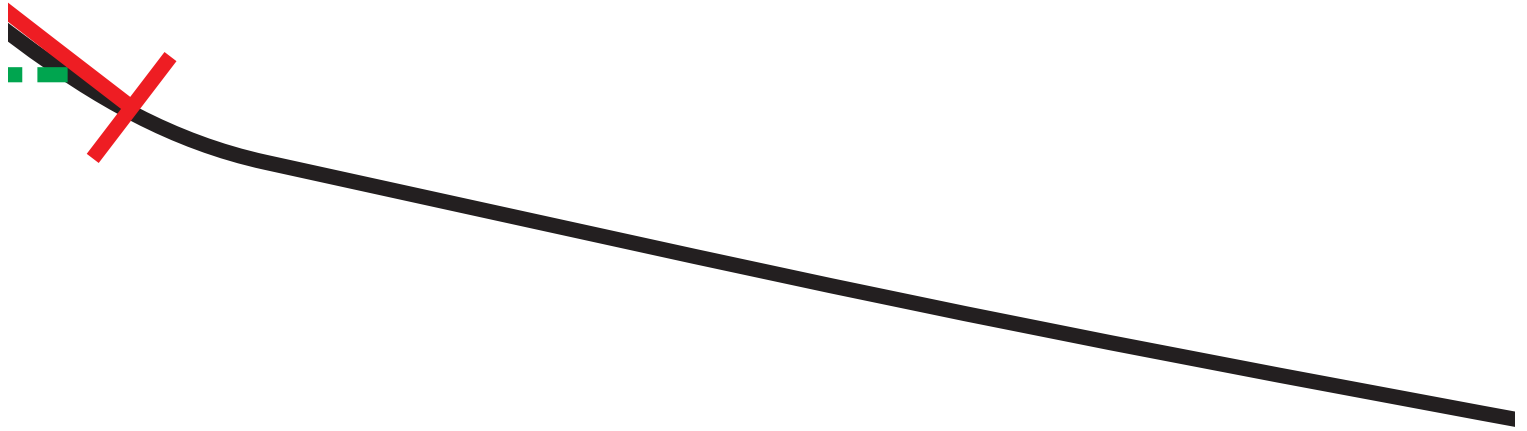

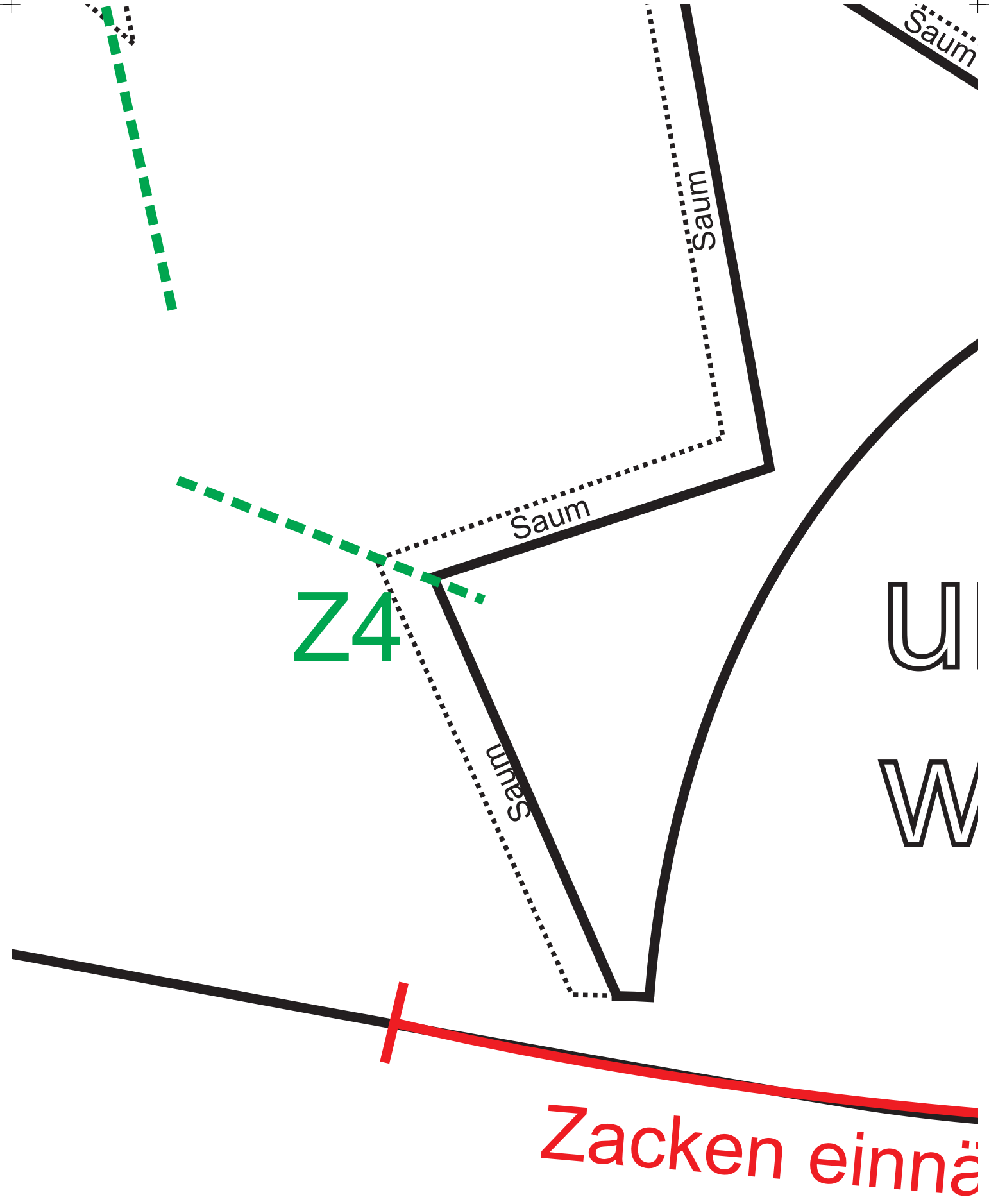

U

W

Zacken einnähen

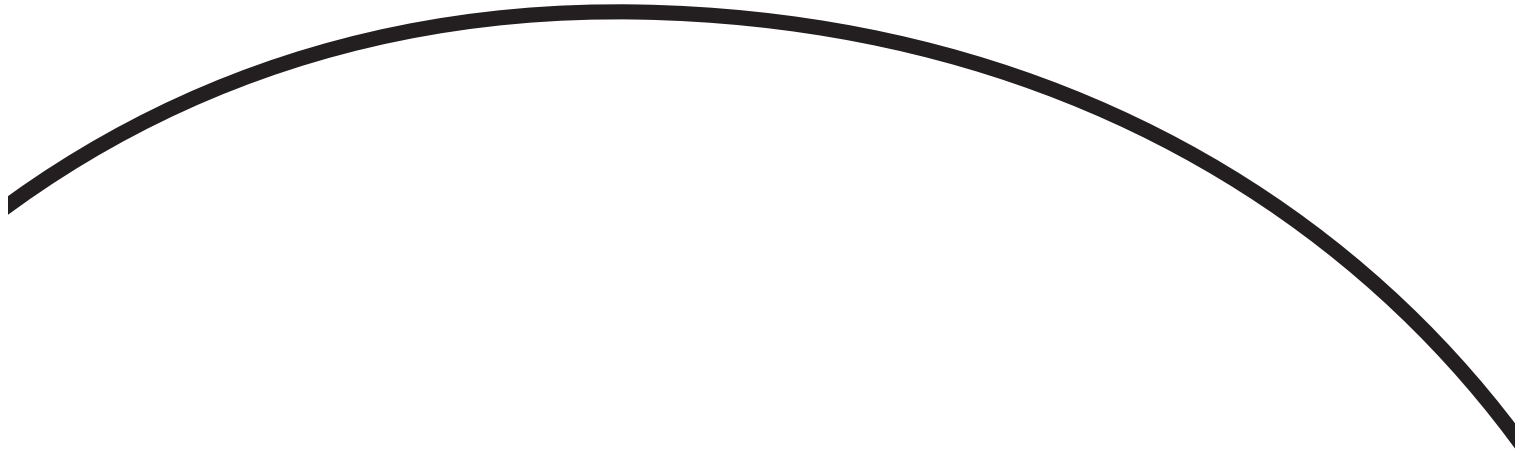
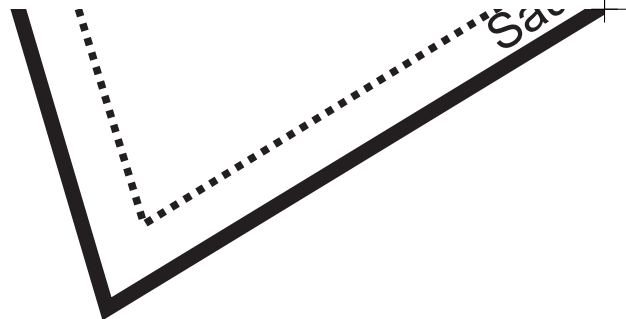
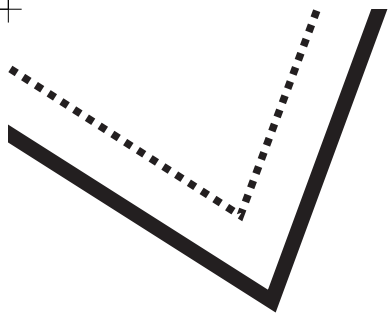

ntere Zähne

weiss 1x



ihen (Nr.4)

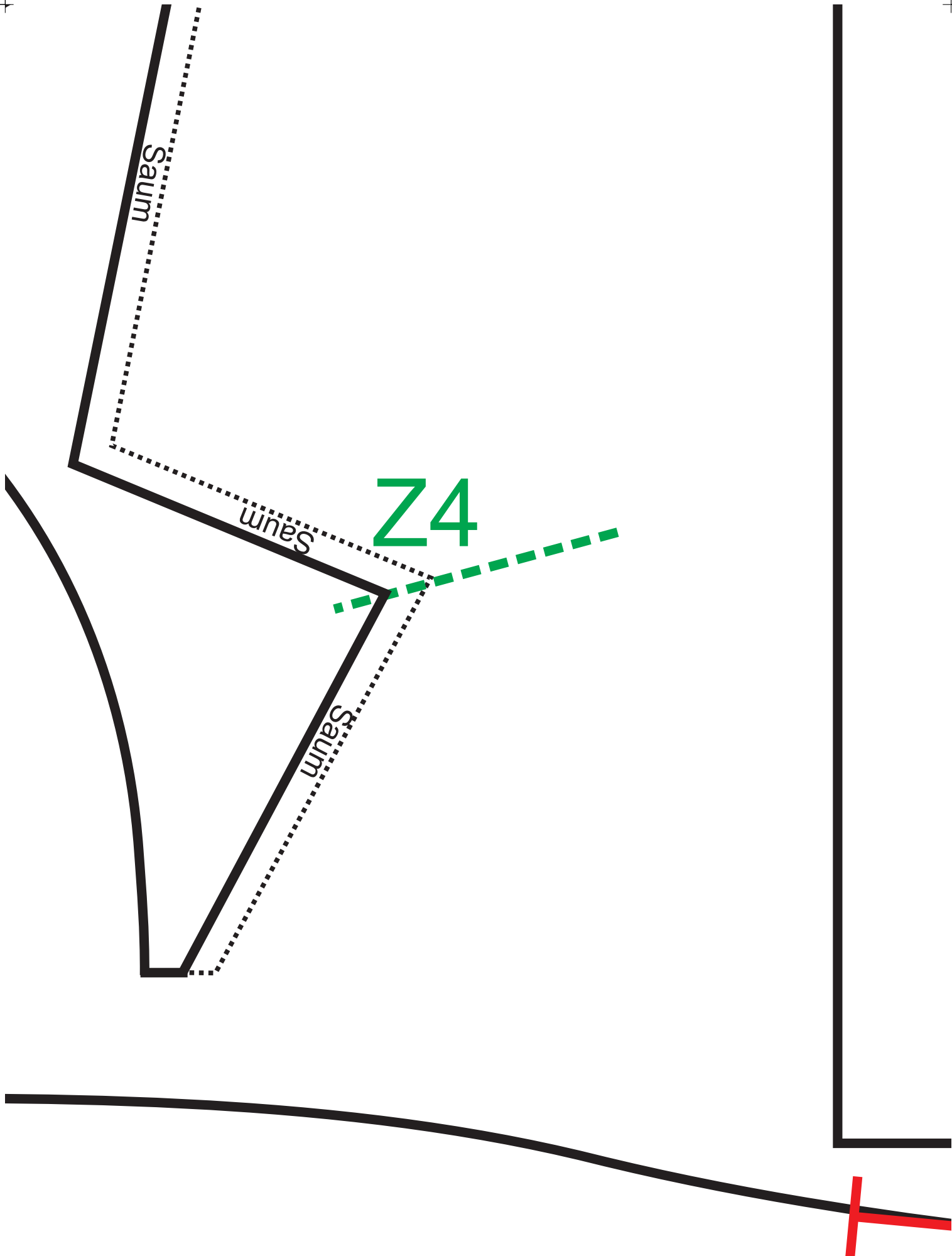

---

Zacken einnähen (Nr.5)



(24, 2)



+

+



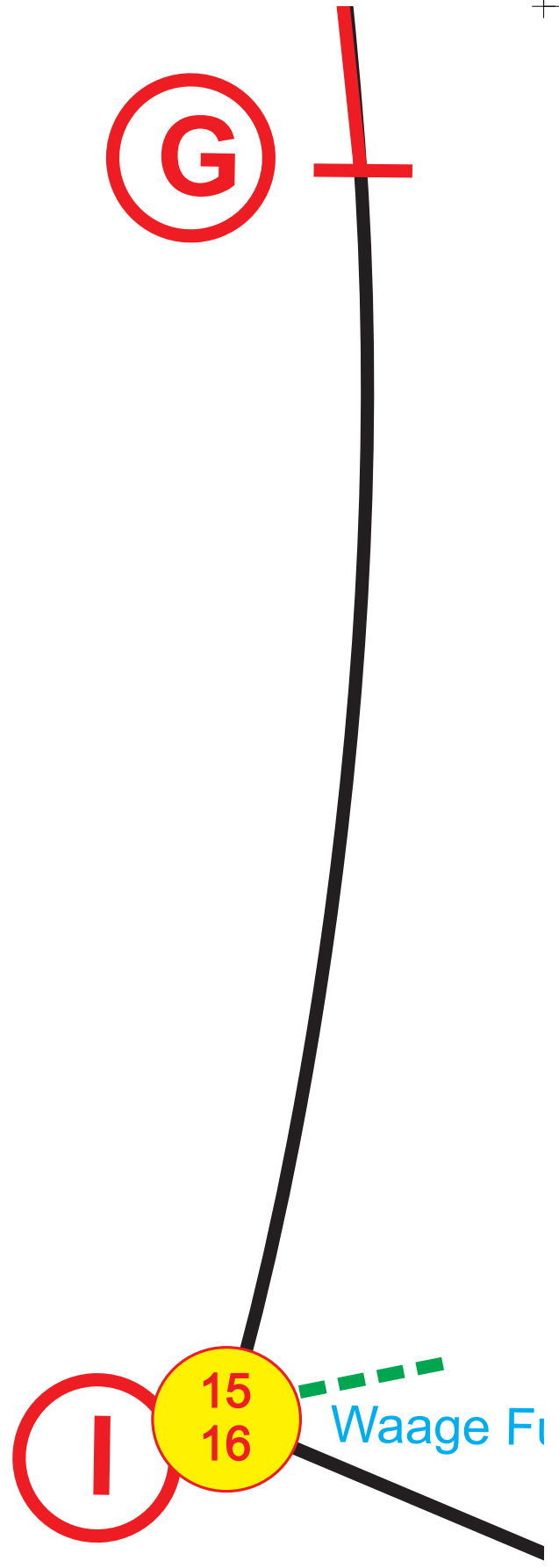

uß vorn

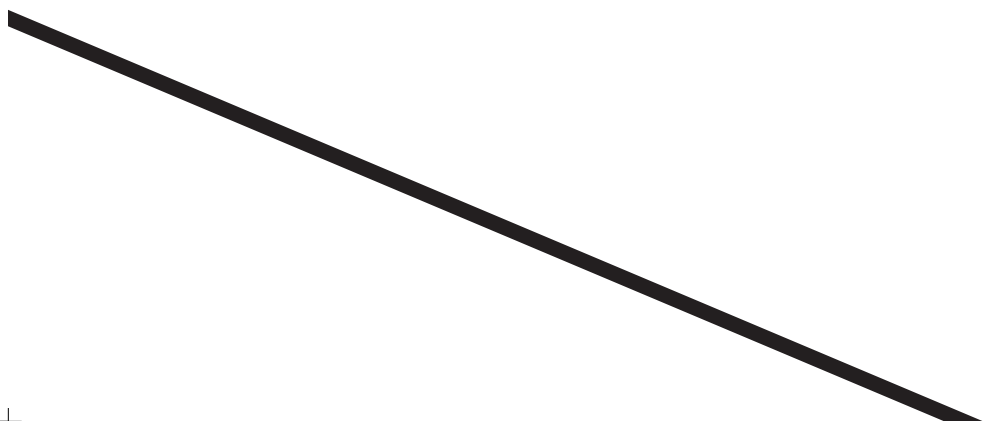

(3, 3)

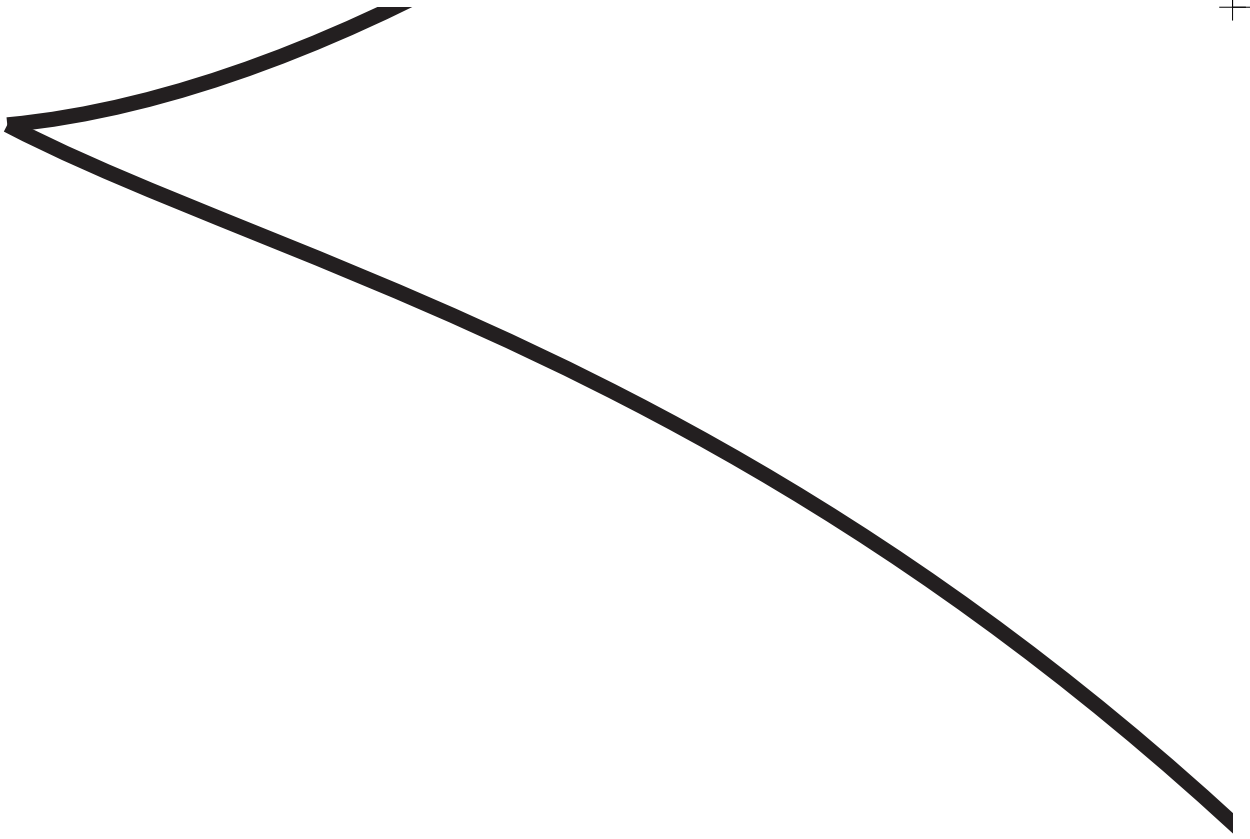

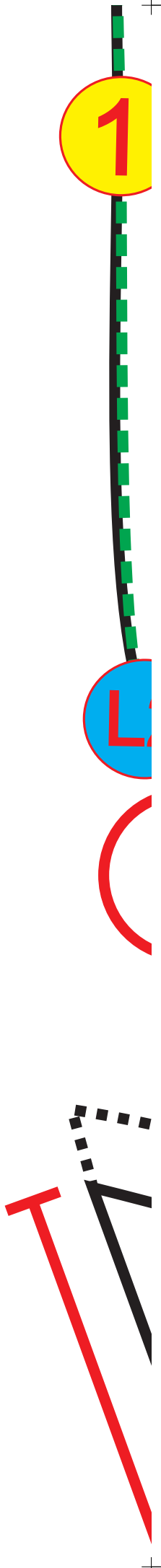
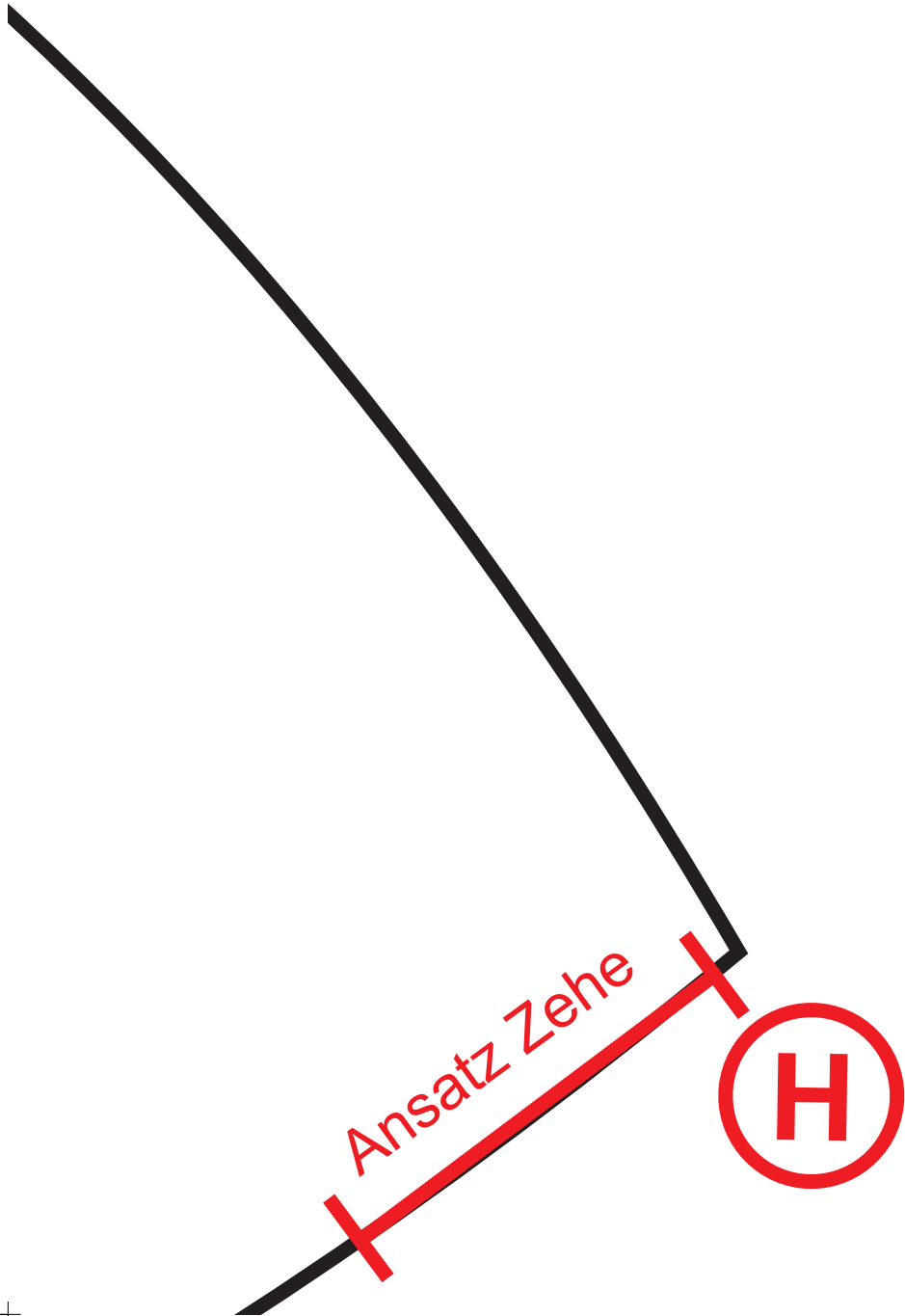



2 Lifteraufhängung



B

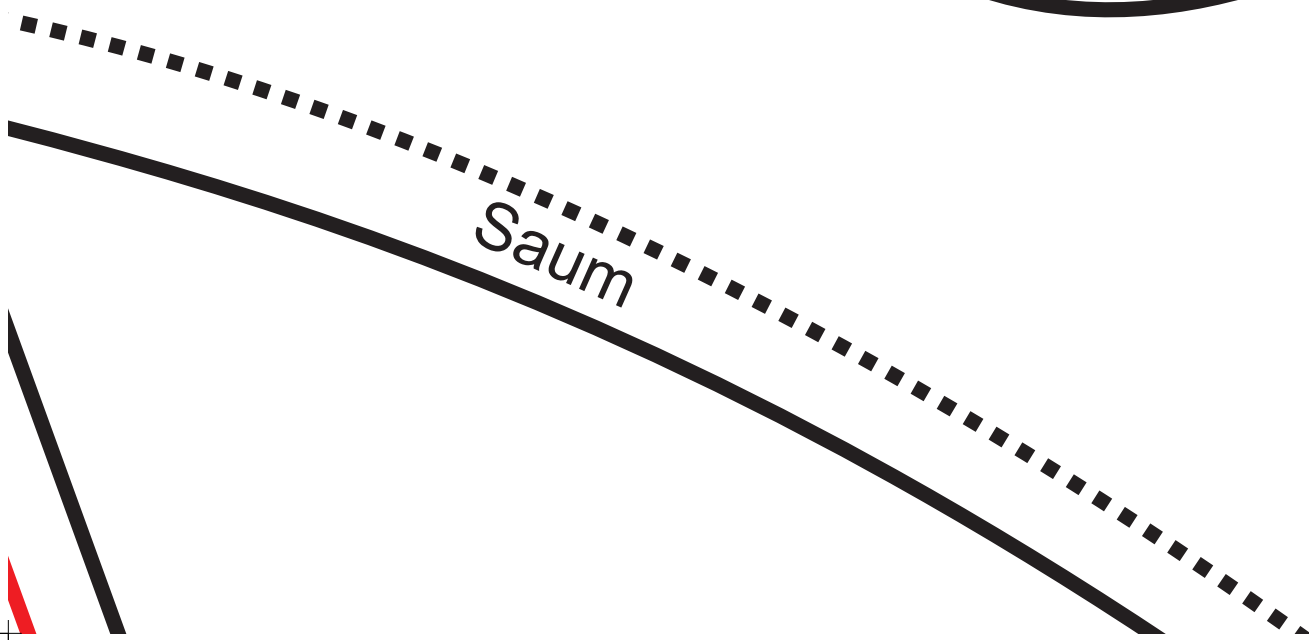
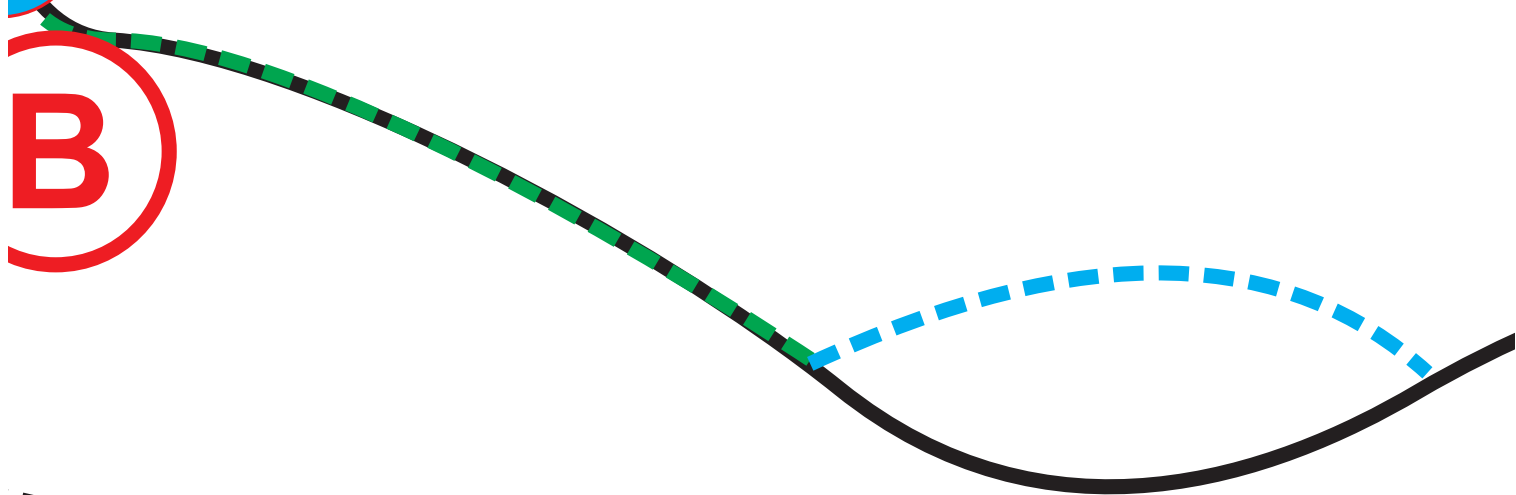

Saum



(7, 3)

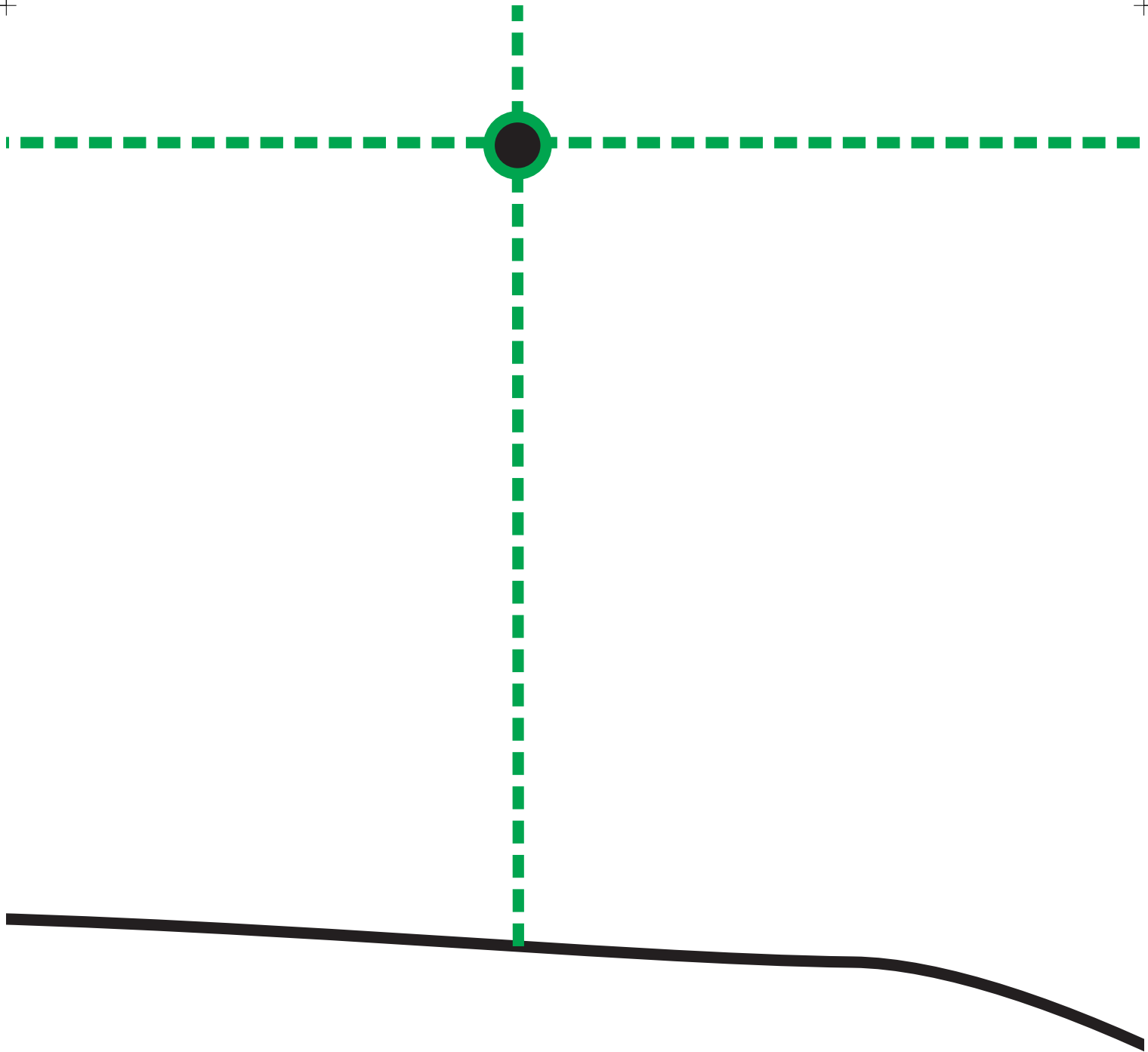

Saum

4 x blau

(8, 3)

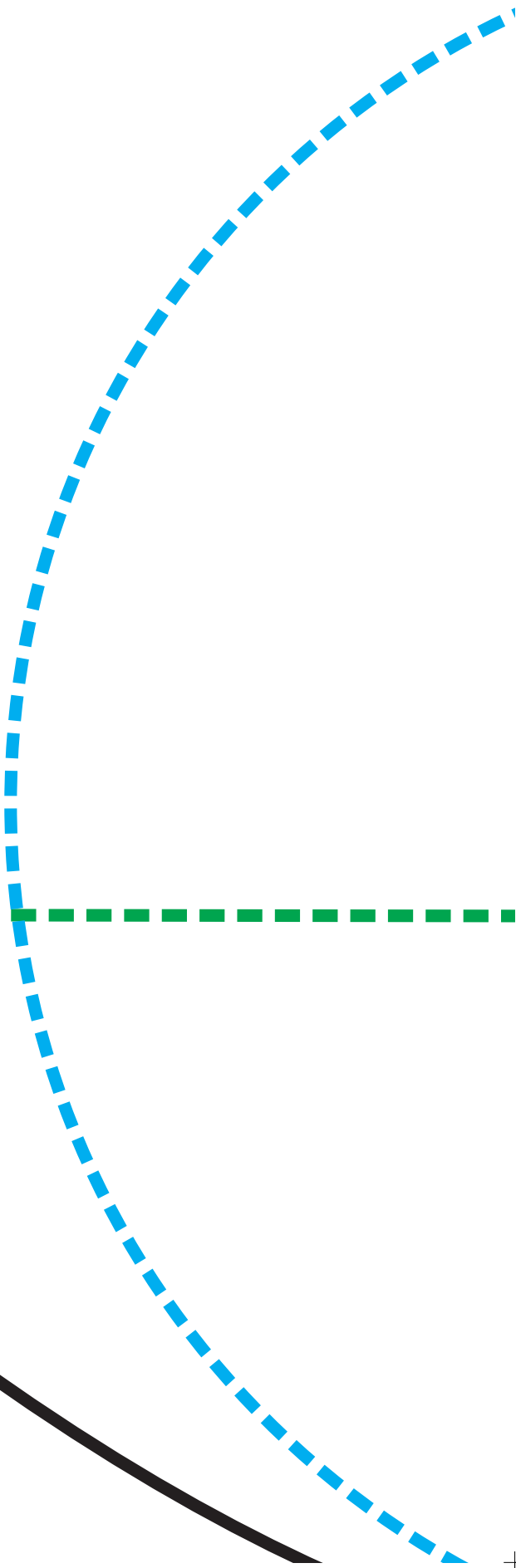
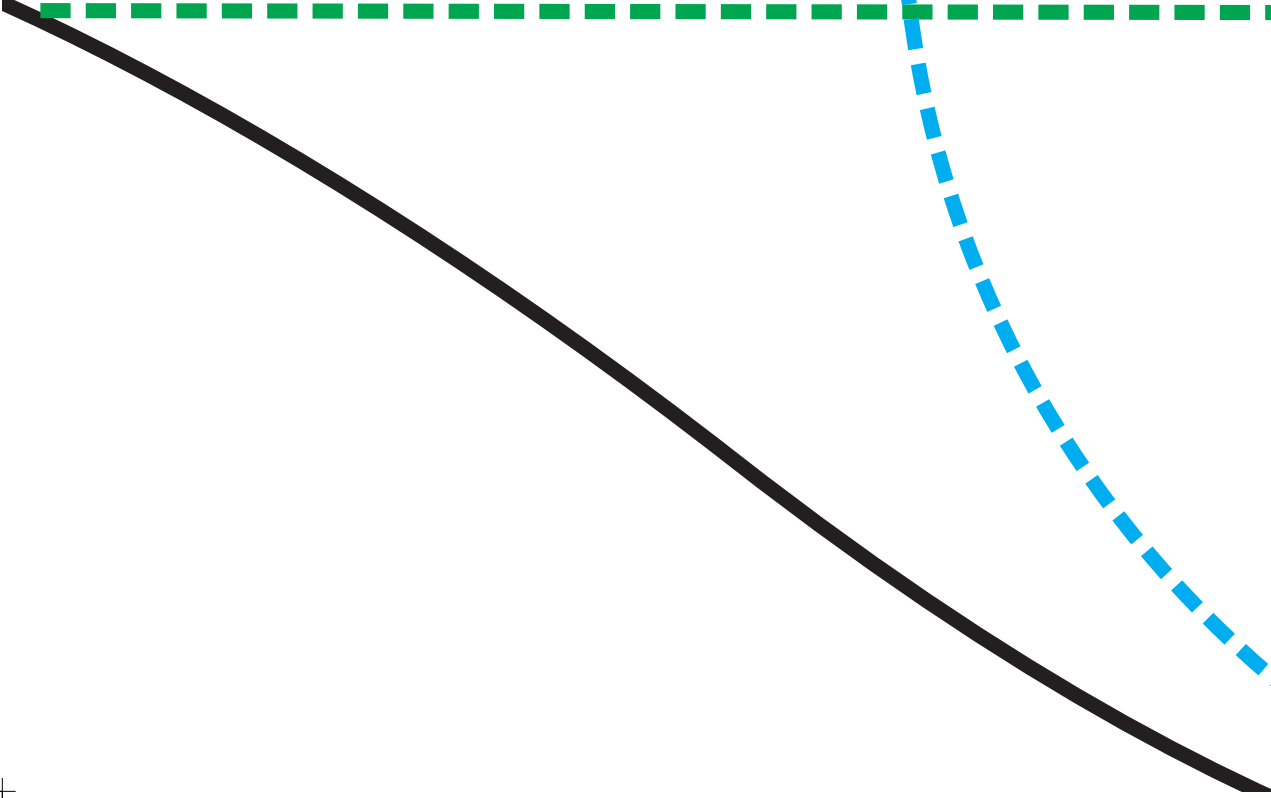



(9, 3)

Umfang 87 cm

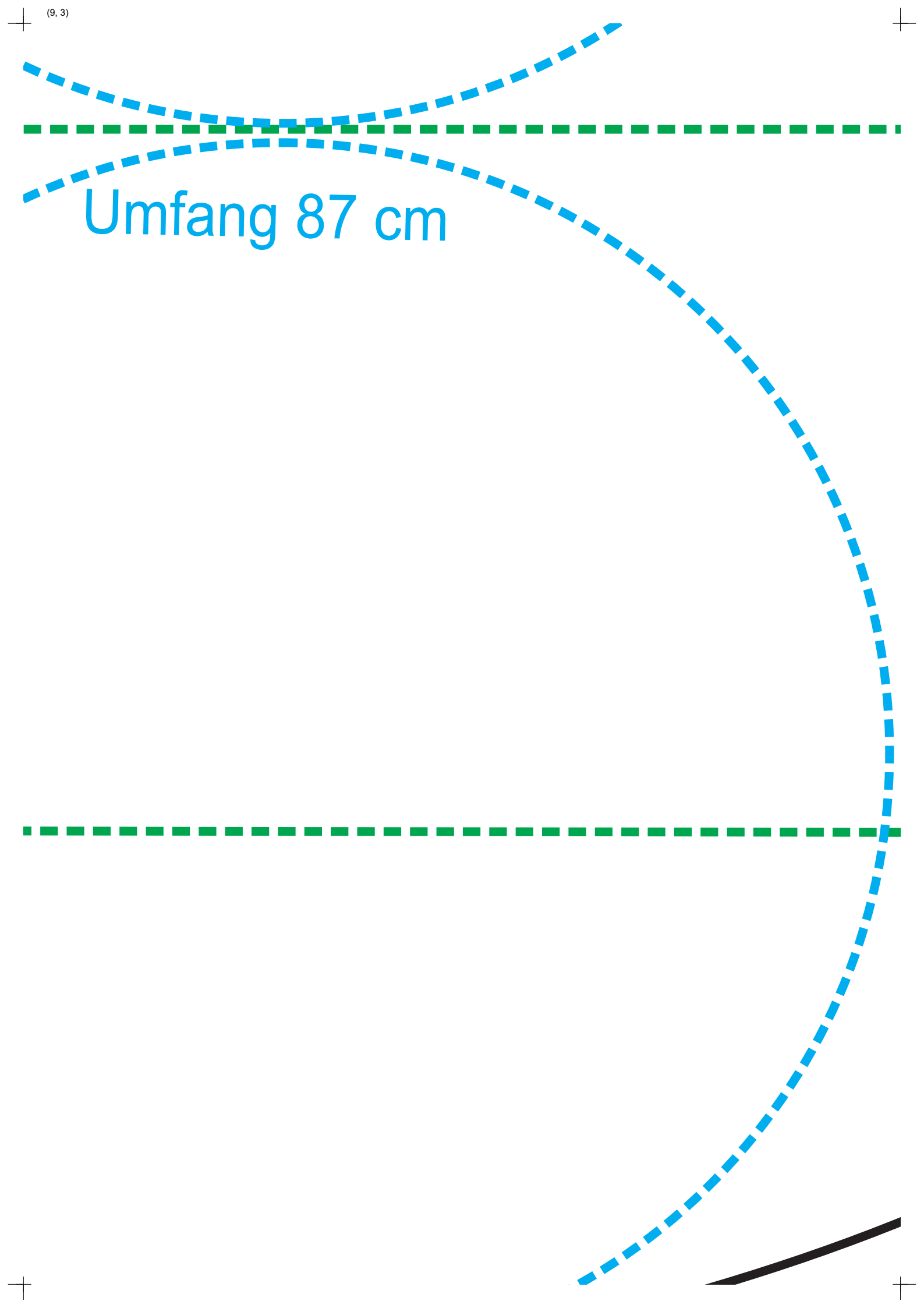

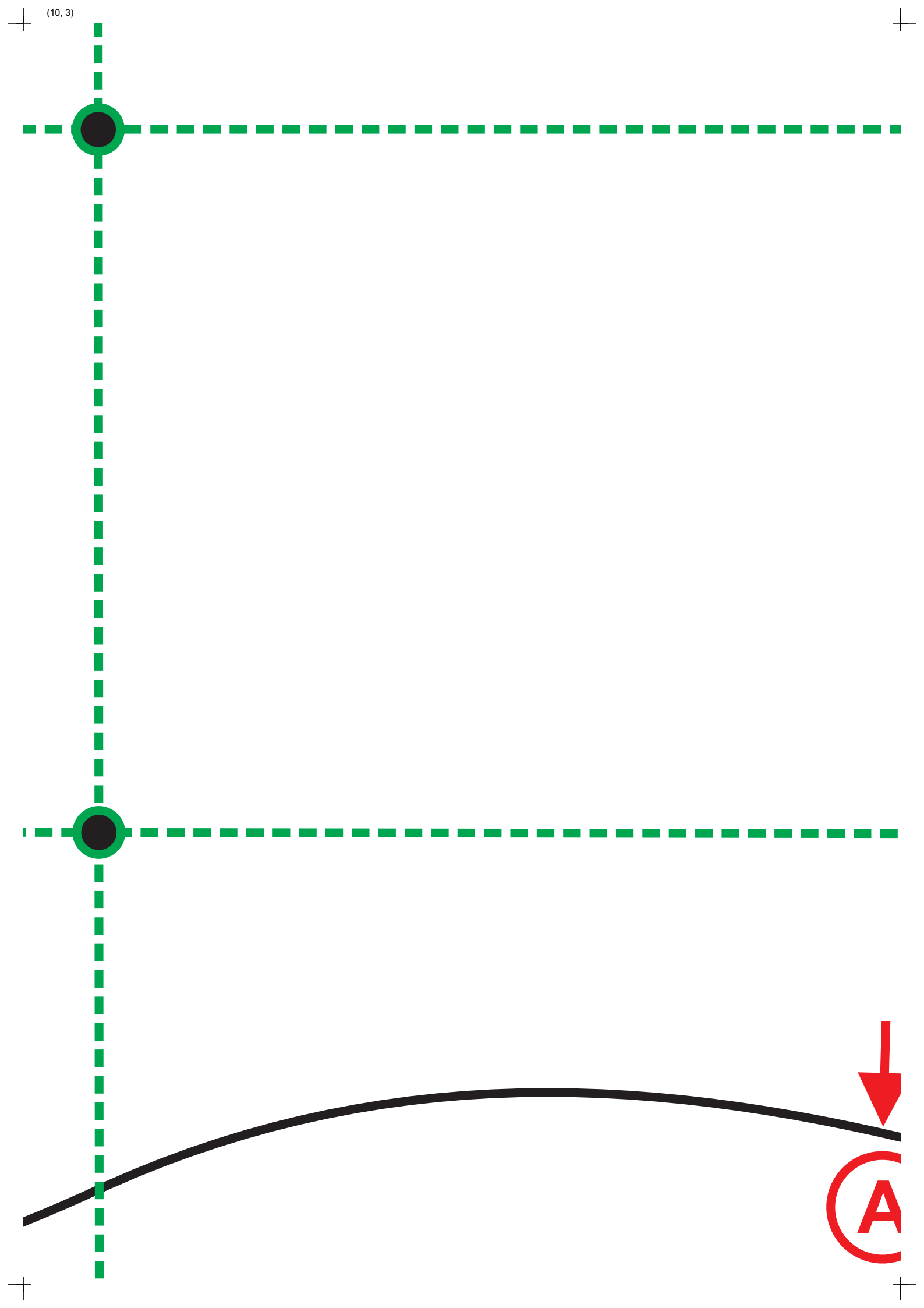

(11, 3)

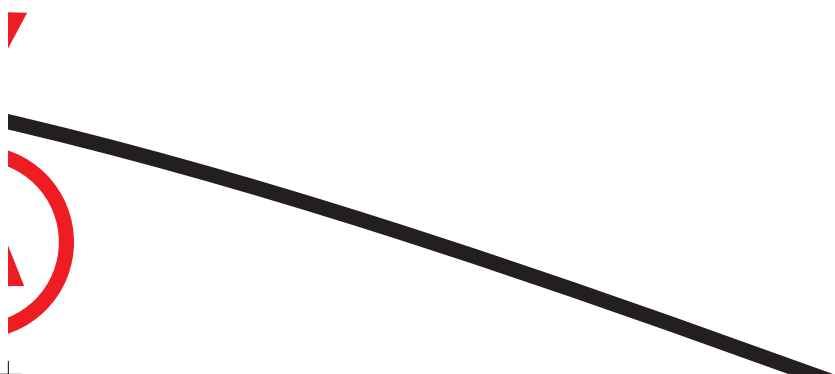

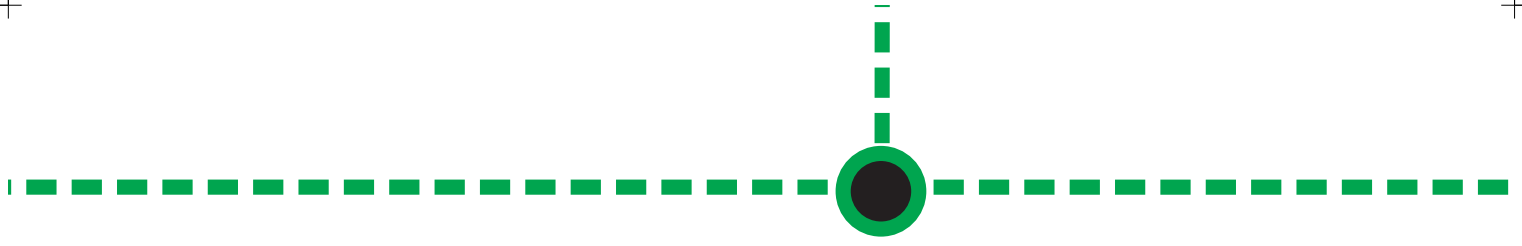

Ok





erseite dun



kelgrün 1x

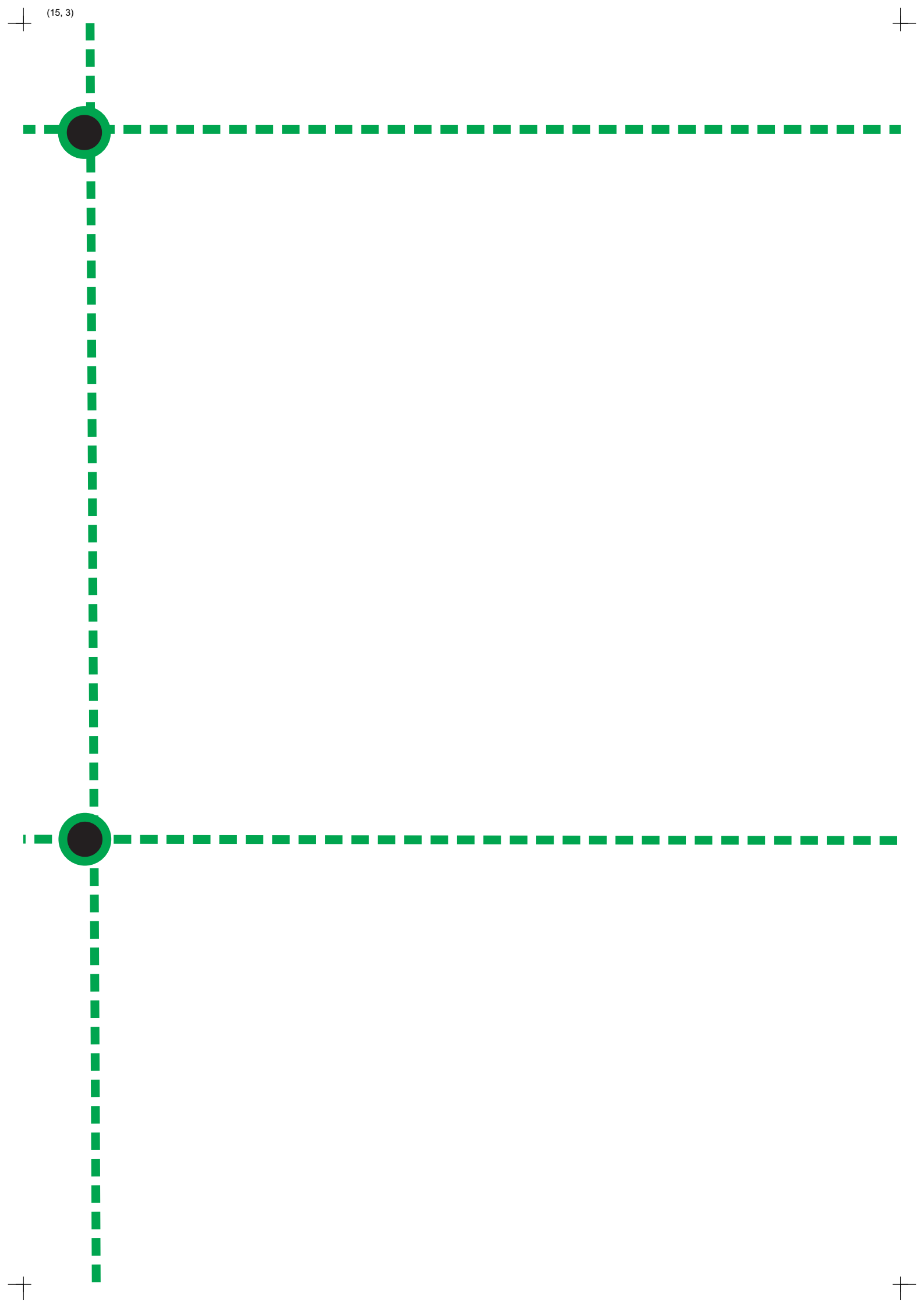





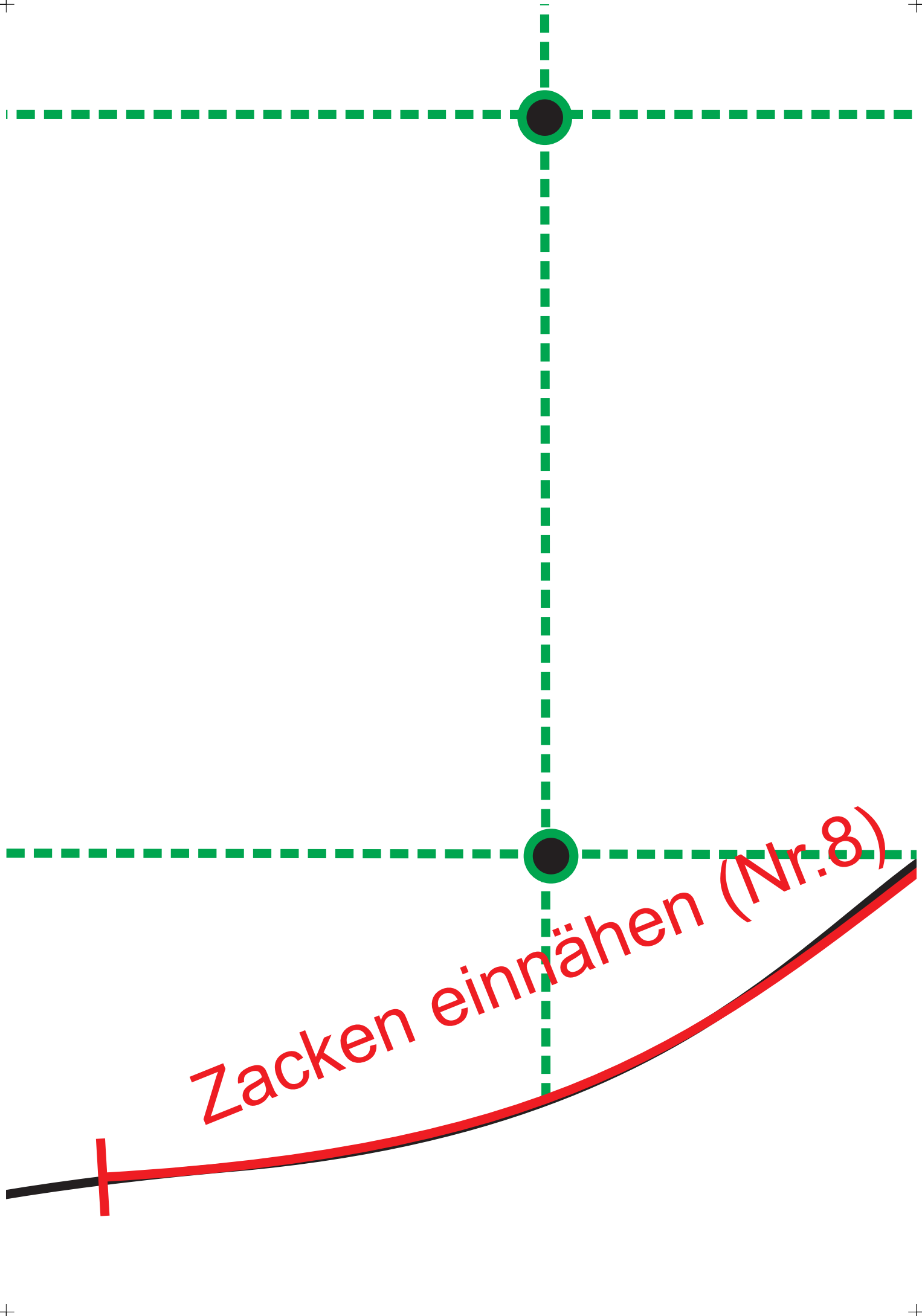

Zacken einnähen (Nr.8)

(18, 3)





Zacken einnä





hen (Nr.9)

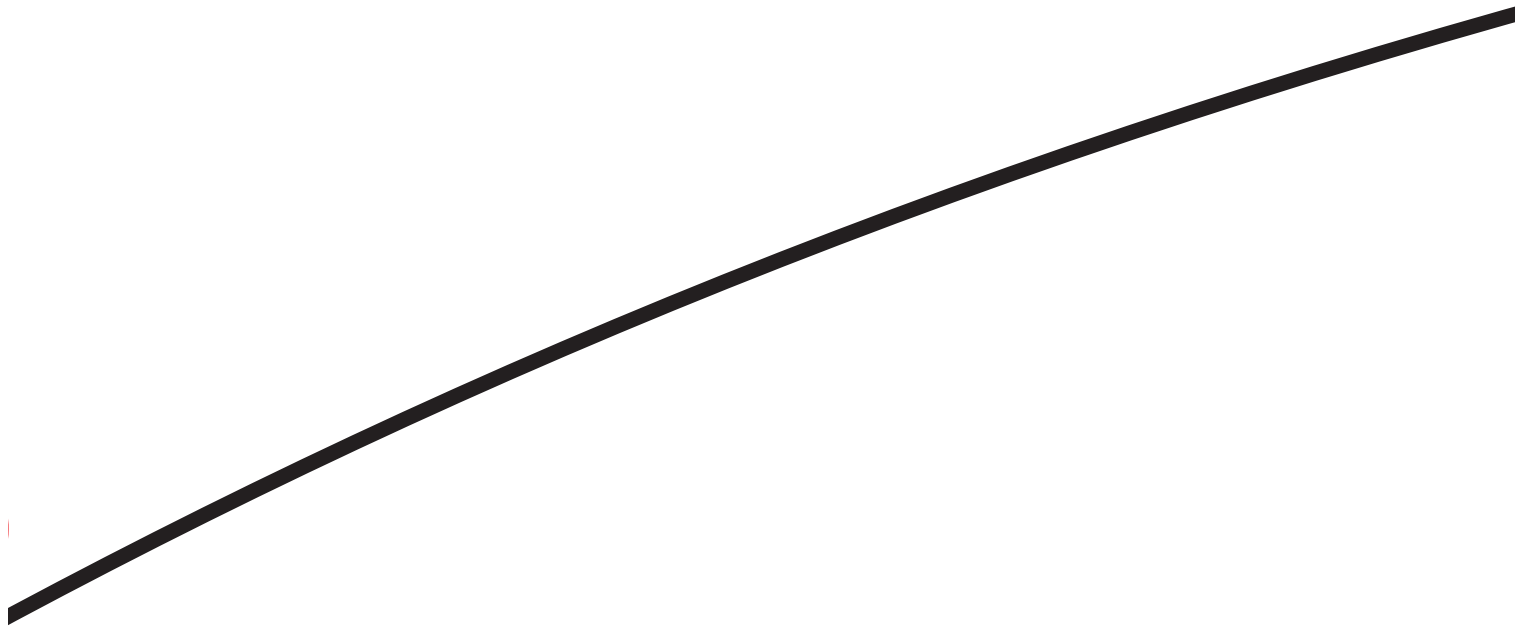

inneres B

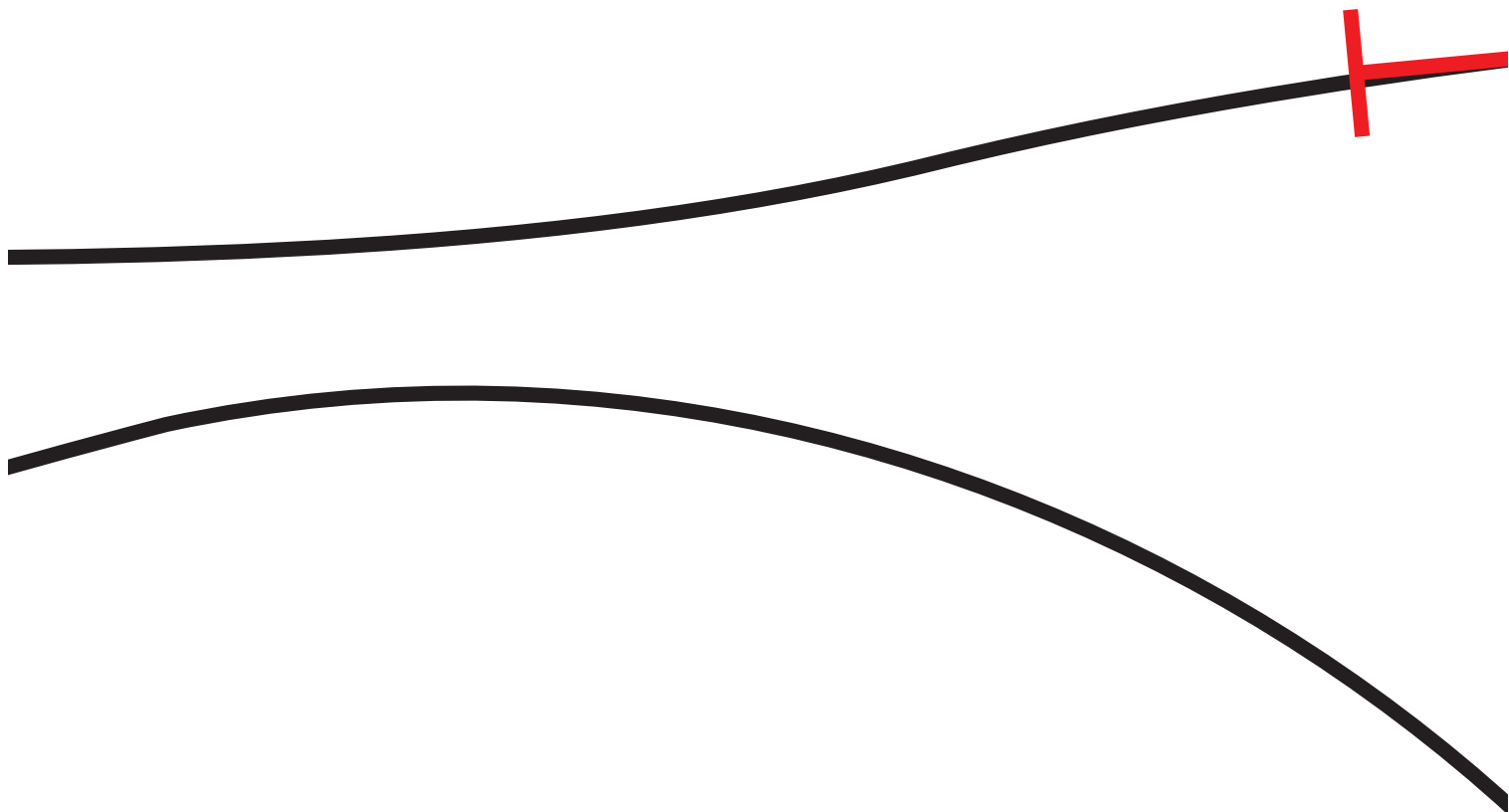

einteil (oben

Zacken einnähen (Nr.10)



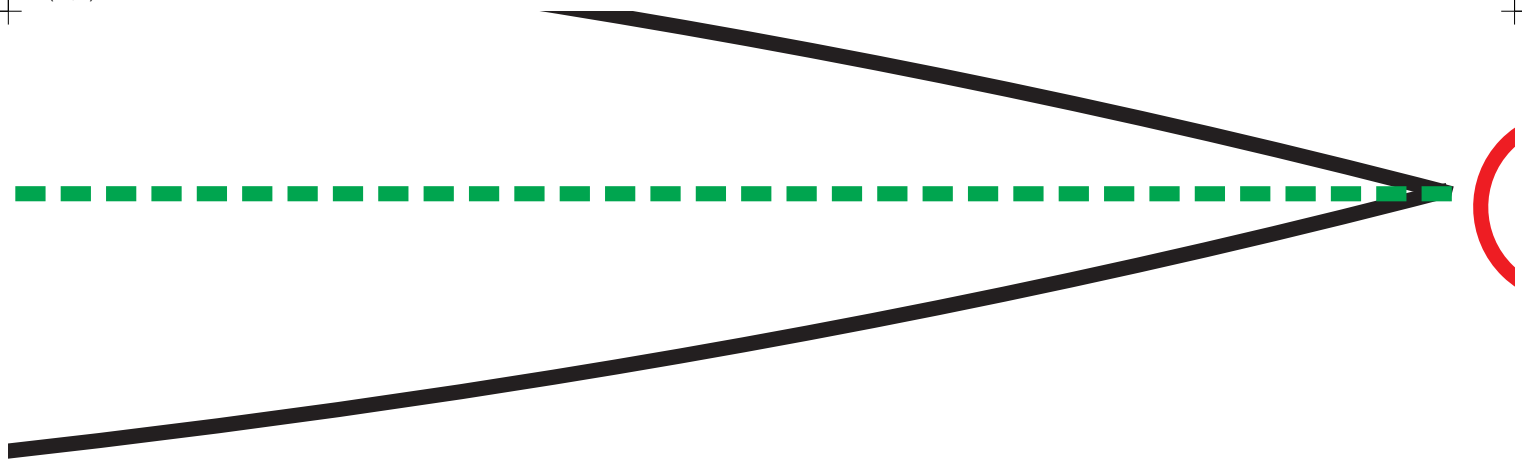

hinten

antillalanne







H



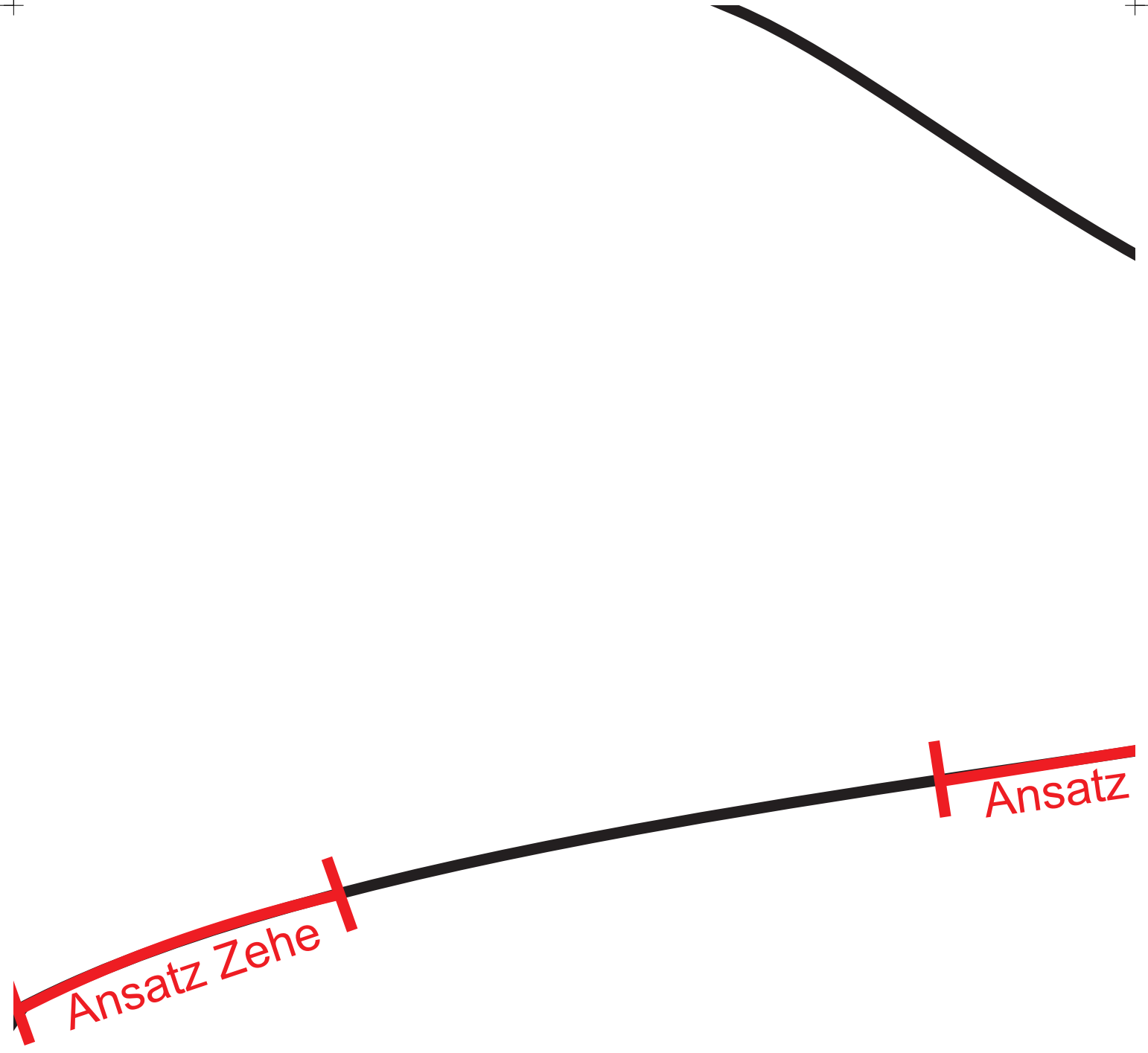

vorn

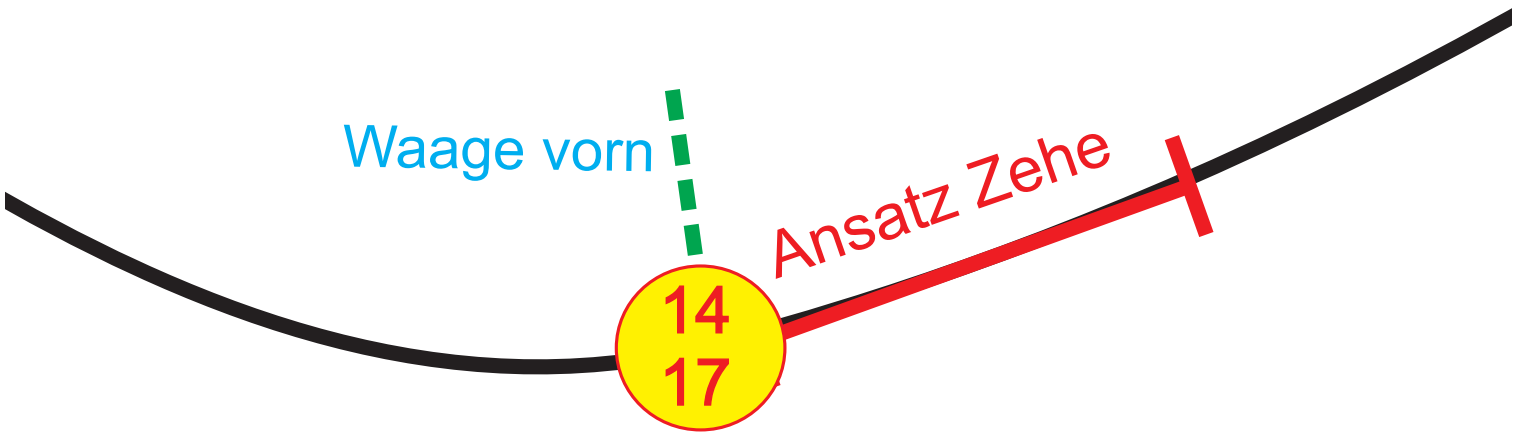

(4, 4)

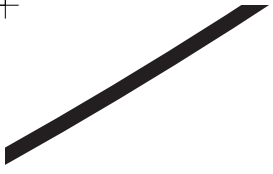

(5, 4)

12

Zacken

blau 24x

21,5 cm

A

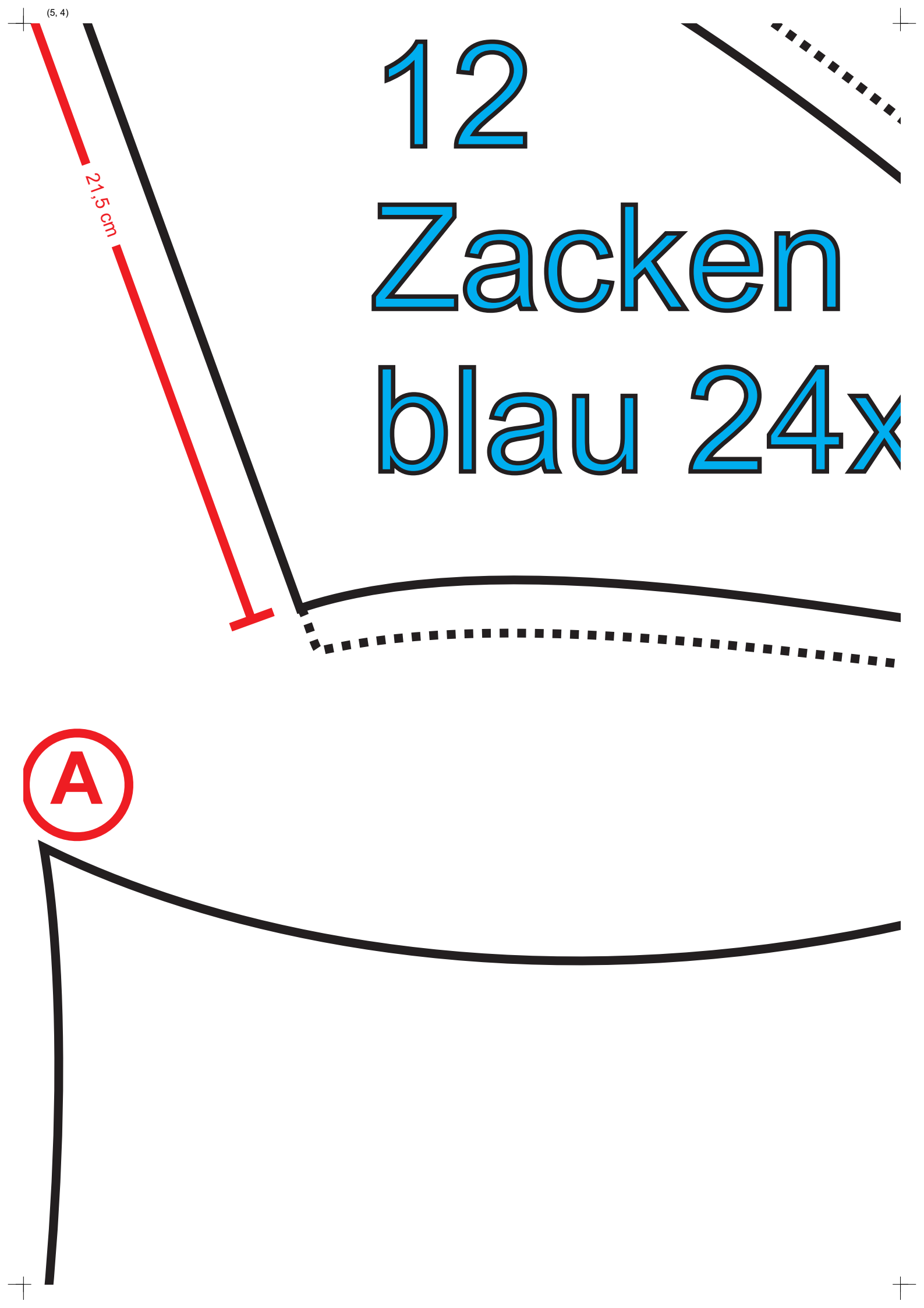



Zacken einnähen (↑)

(7,4)

allen (12 Stück)



Nr. 1/6)



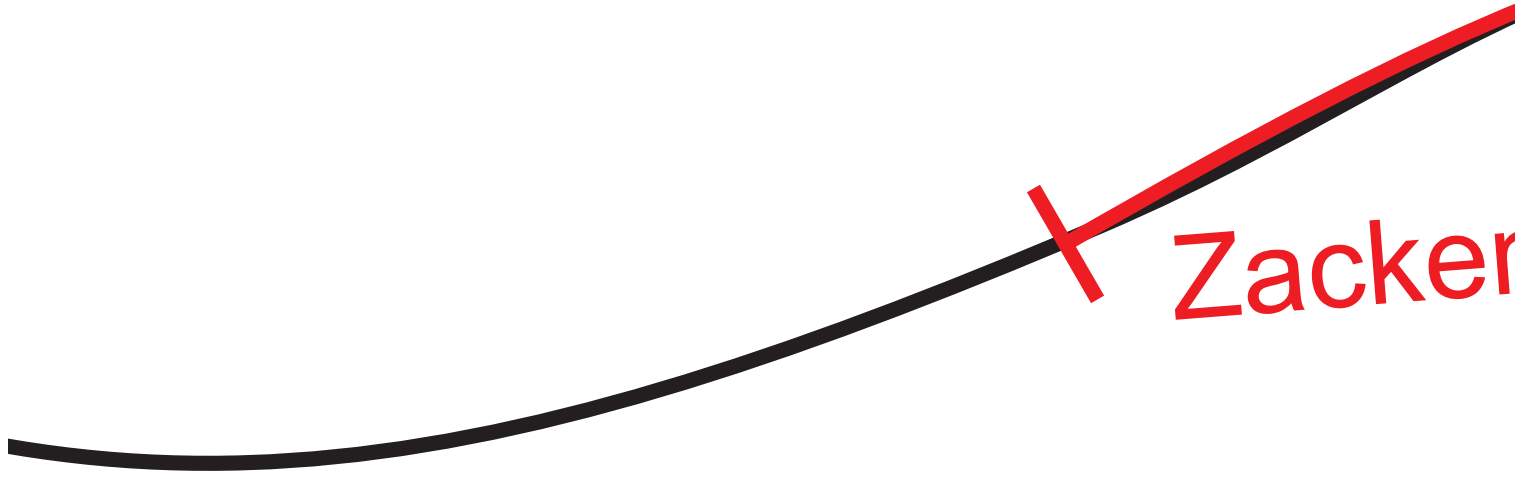

Zacker

Umfang 60cm

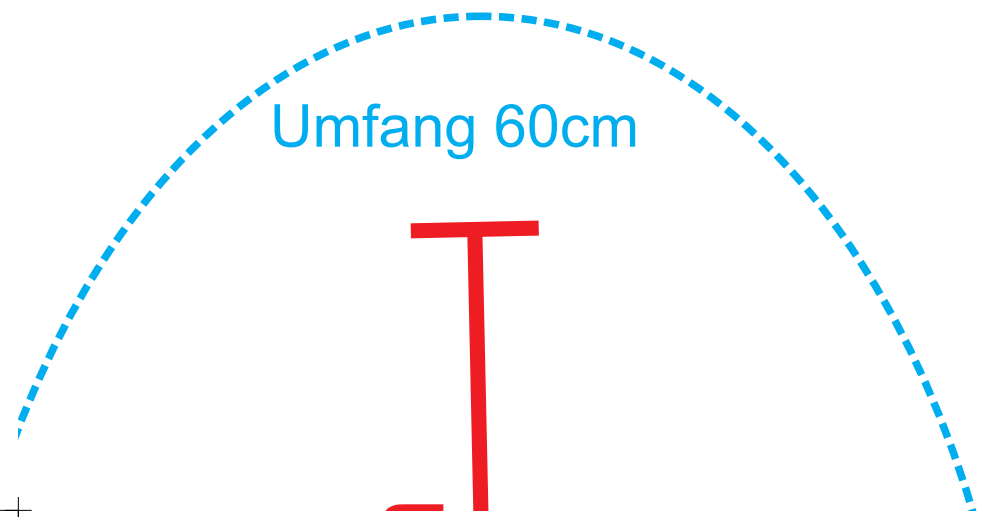
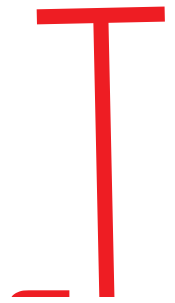



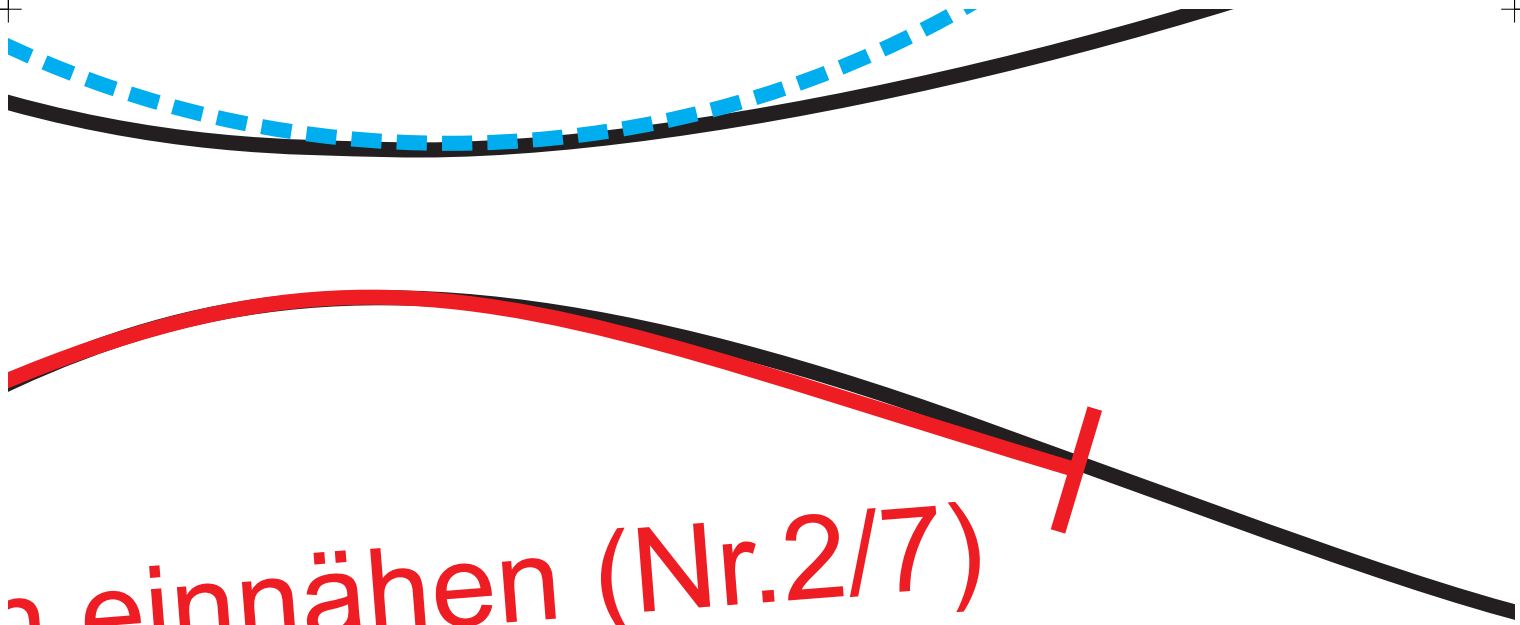

1 einnähen (Nr.2/7) /



(10, 4)



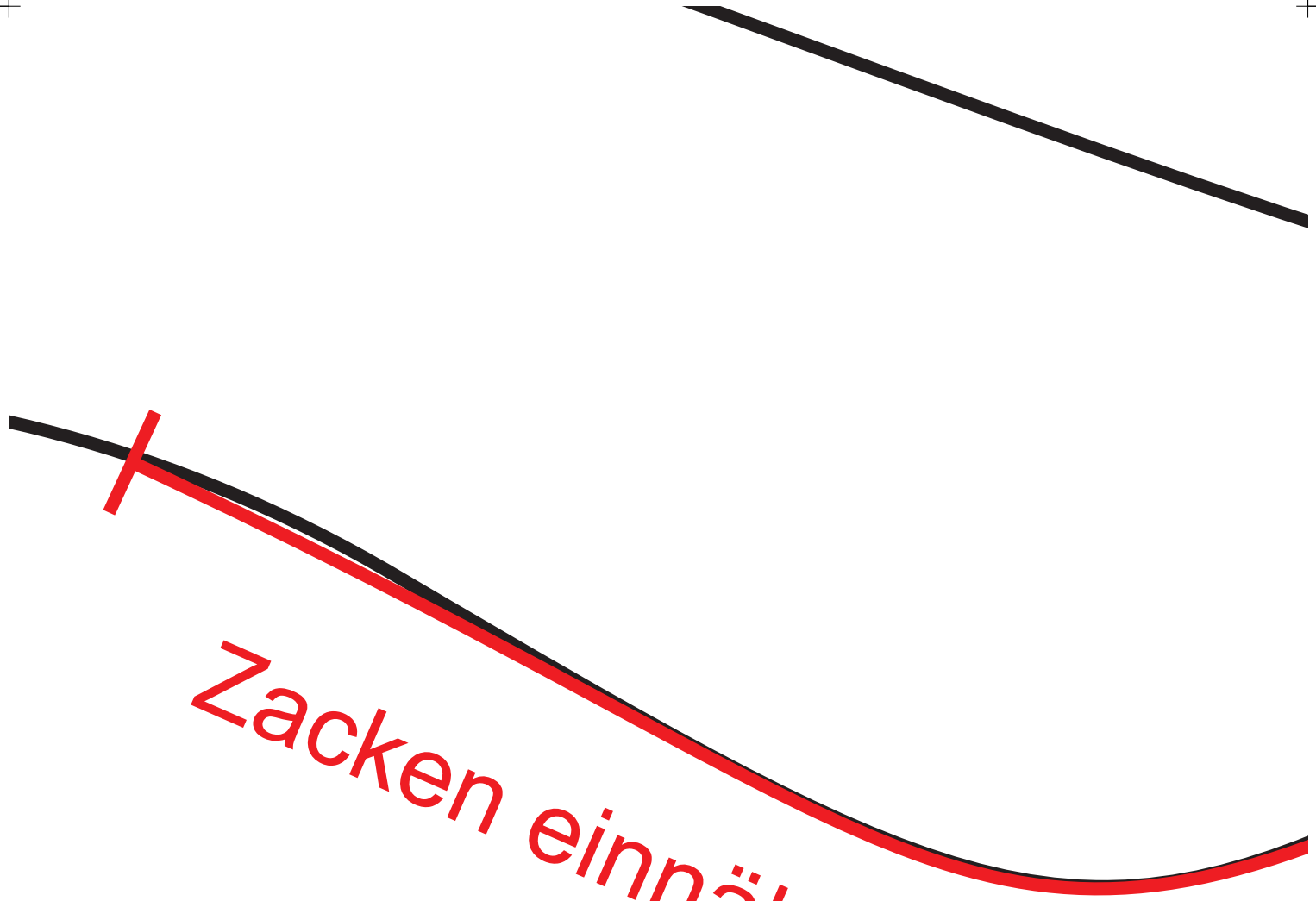

Zacken einnähen (Nr. 3/8)

Zackeneinnähen (N



Ir.6)

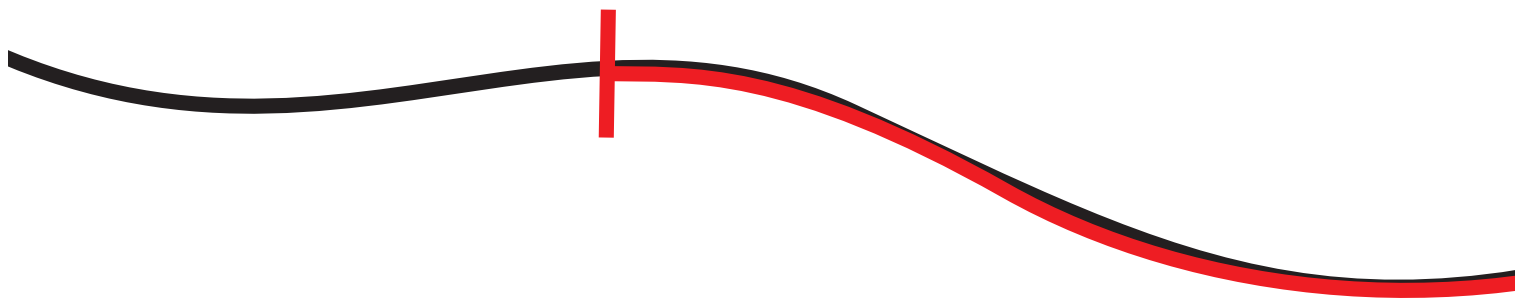

Zacken einnäh



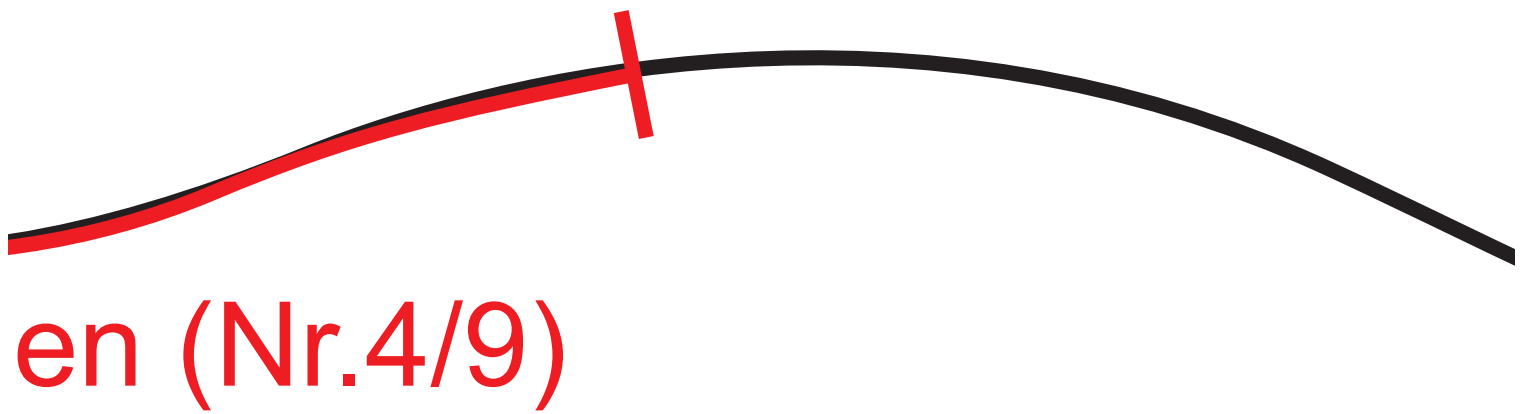
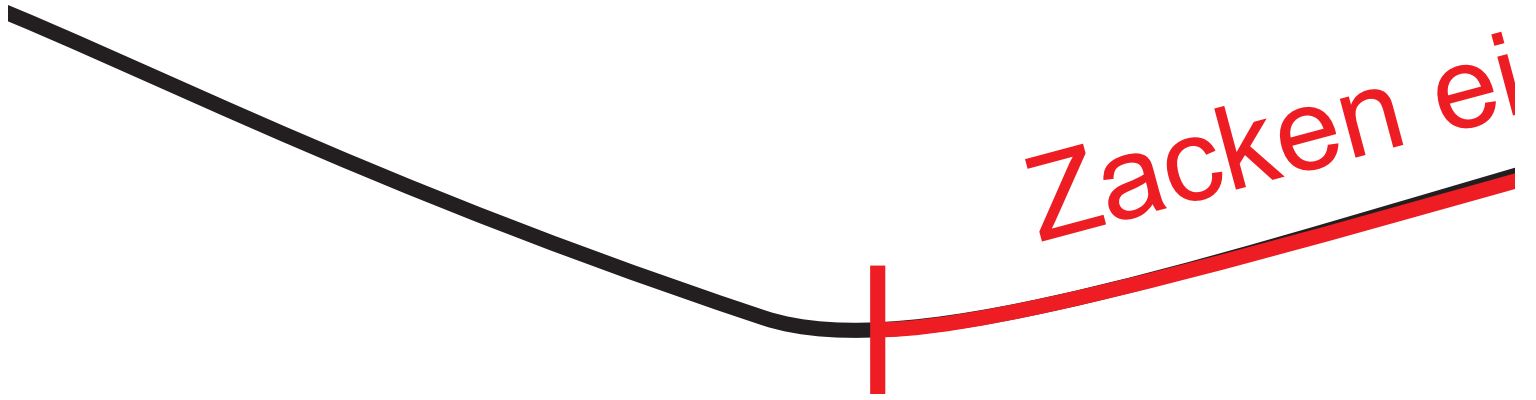

Annäheren (Nr.7)



$Z_{\varepsilon}$



acken einnähen (Nr.5/10)







Zacken einnähen

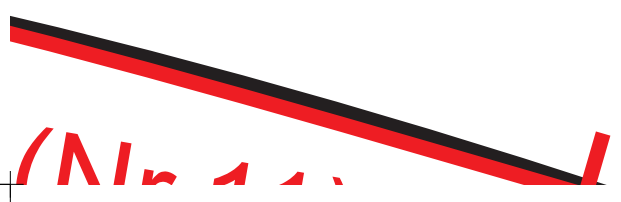

(Nur 1...)

©

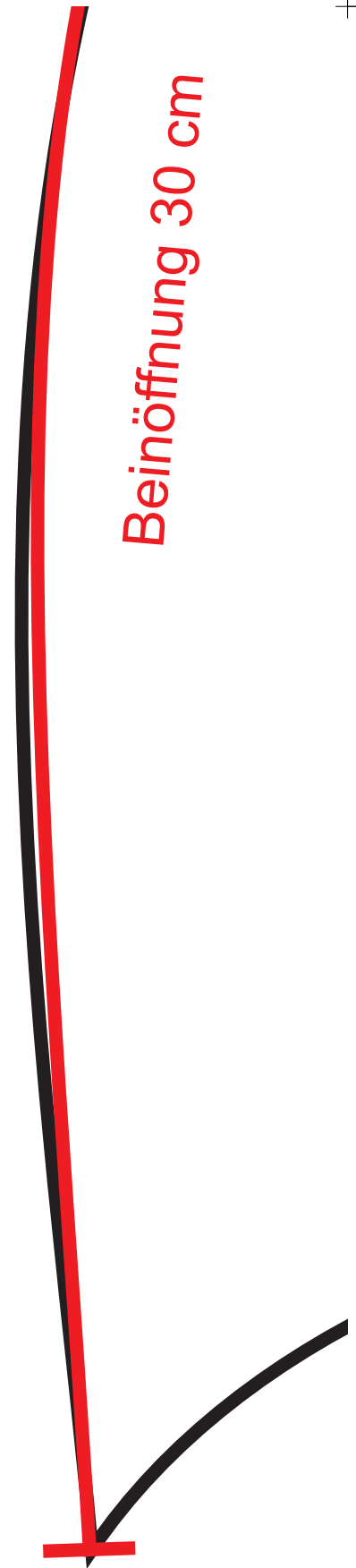

Beinöffnung 30 cm

hellgrün 4



X



L

(22, 4)



V E

W E

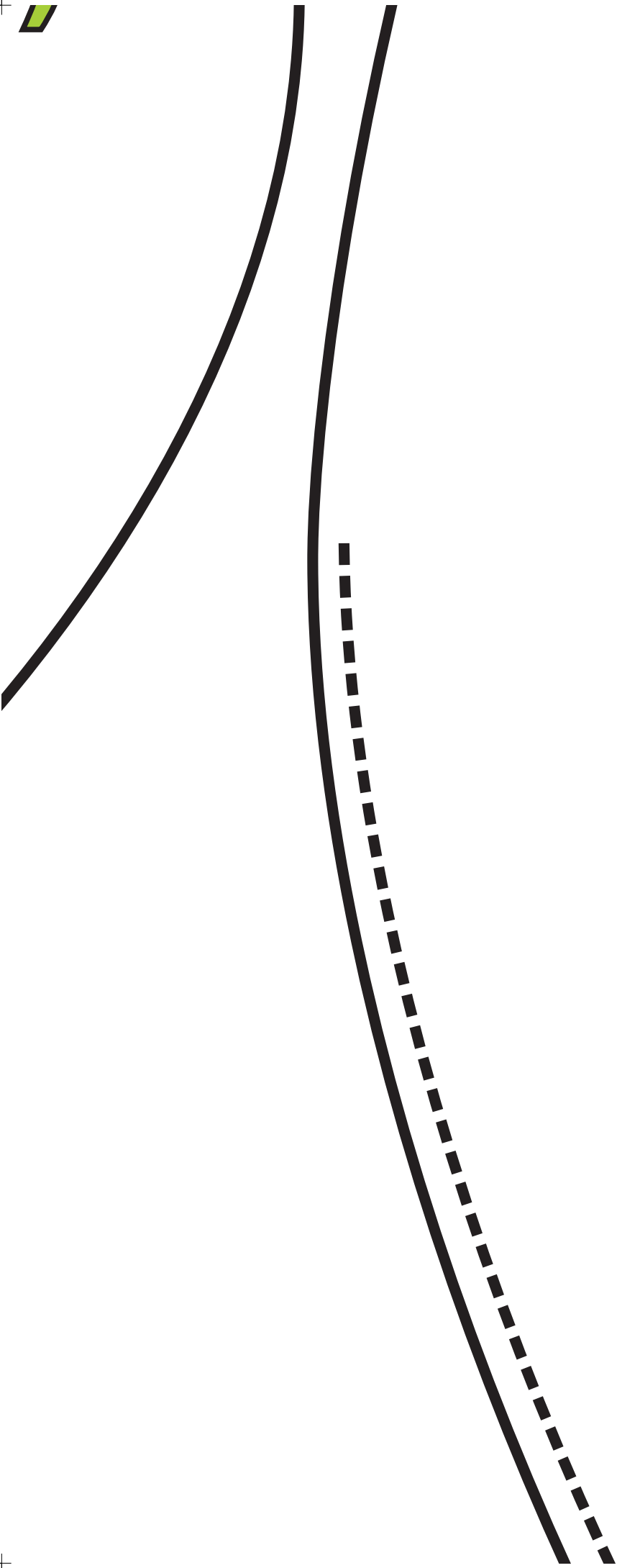

гн лшкппг

eiss 1x

(24, 4)

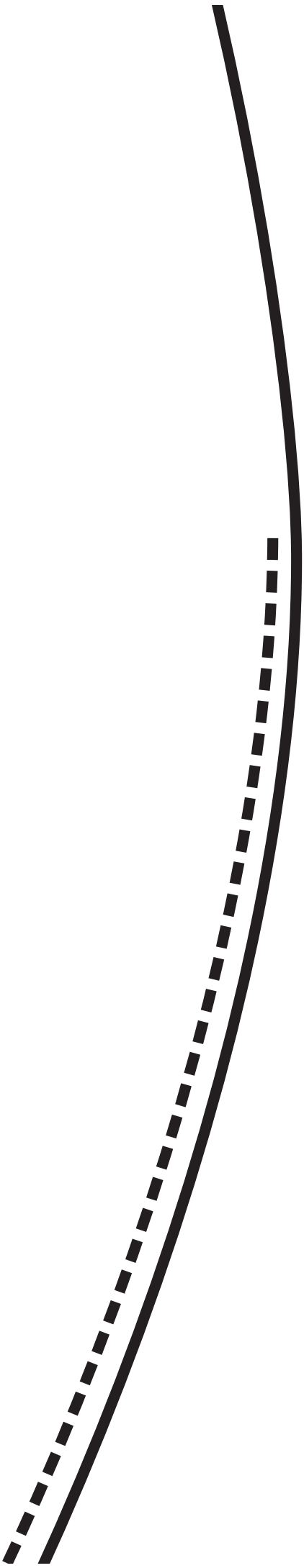



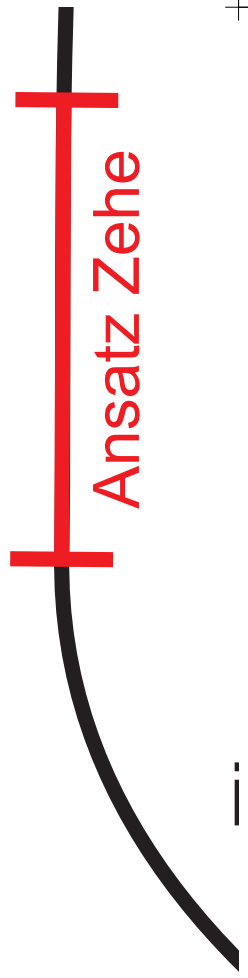

# Fußsohle g

innen



# gelb 4x

Waage  
nur an  
vordere  
FüÙe

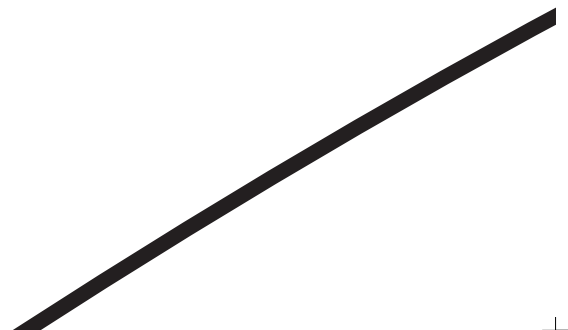

(4, 5)

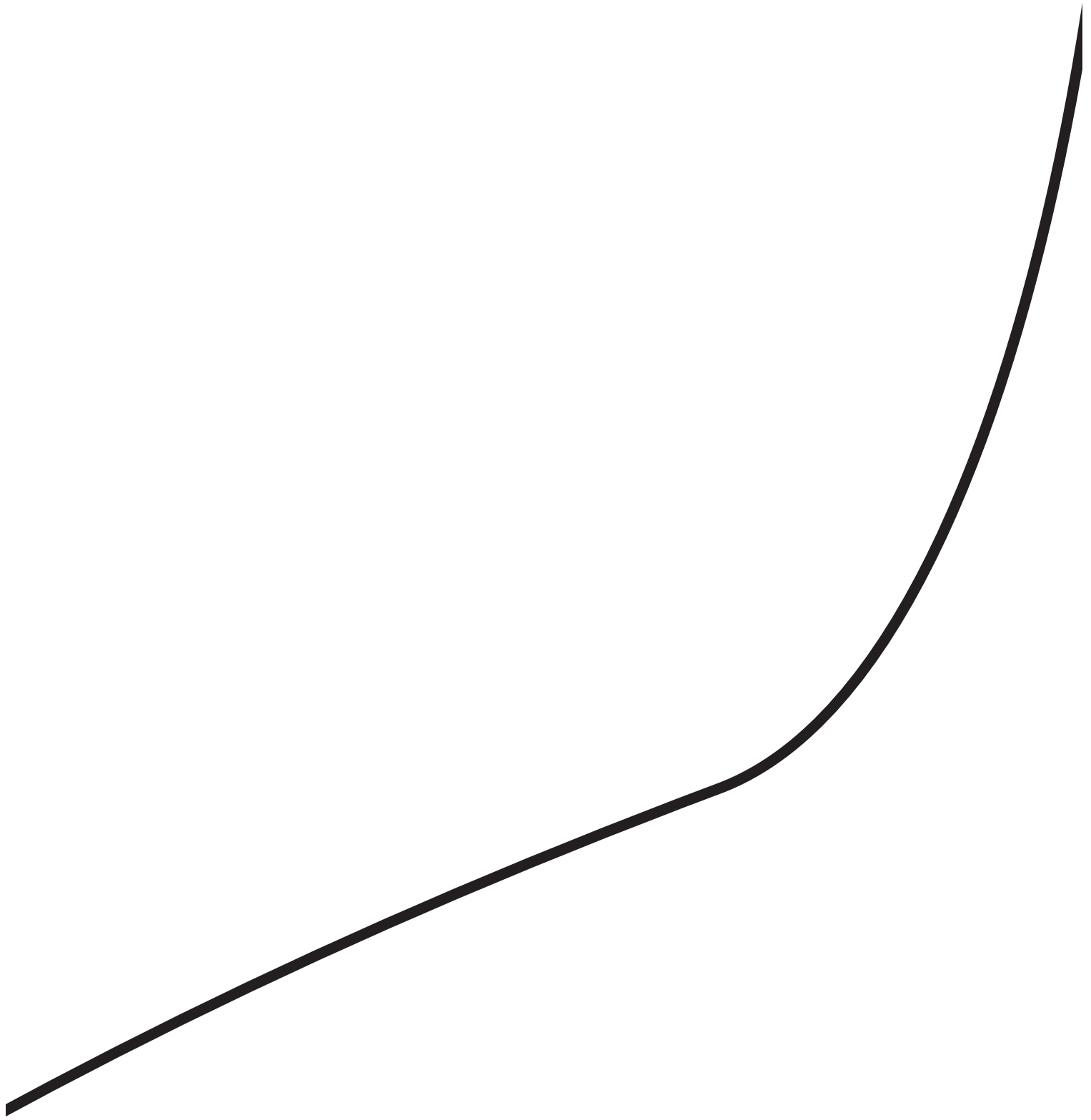





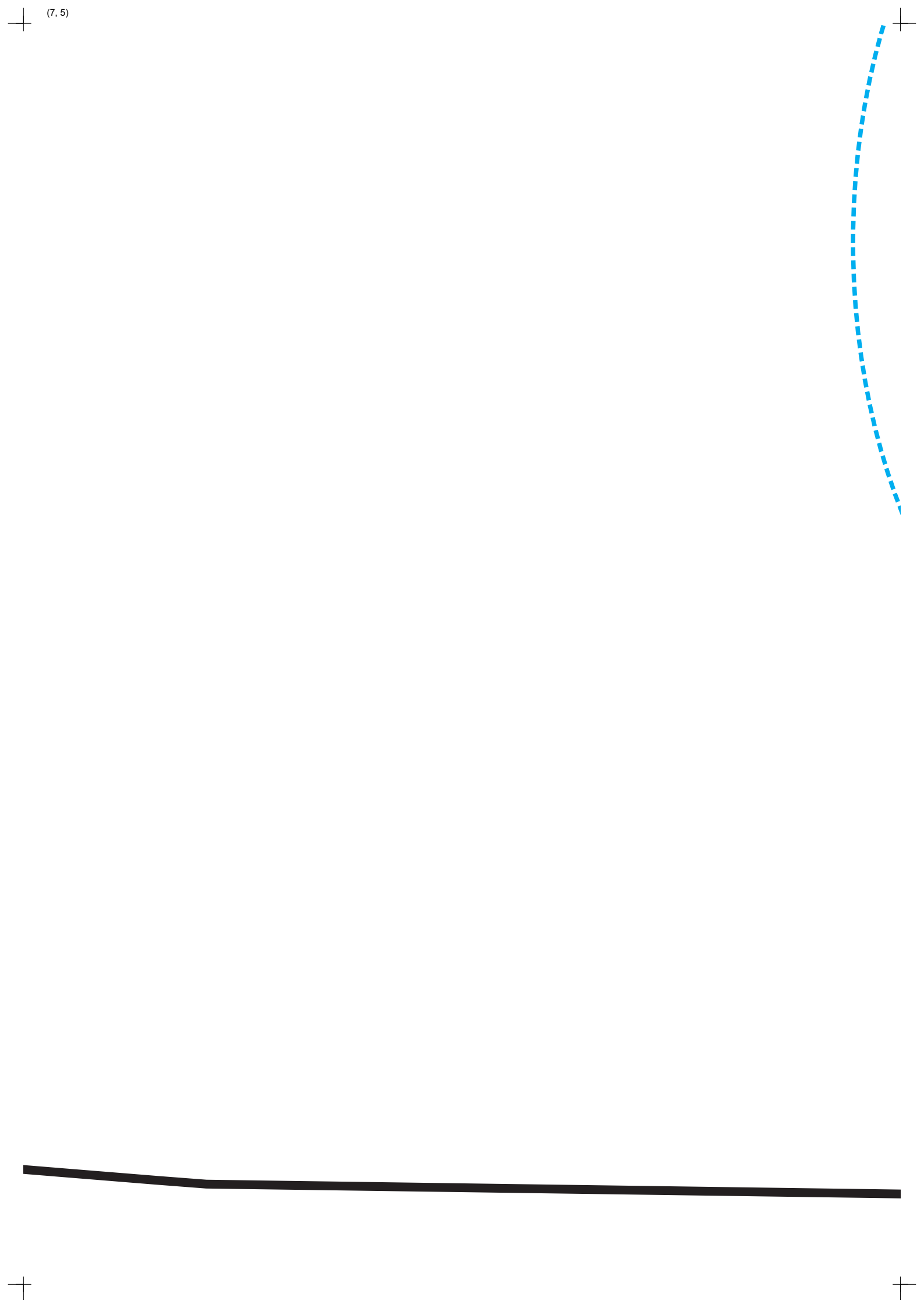

Öffnung Bein

dunkelgrün

hellgrün

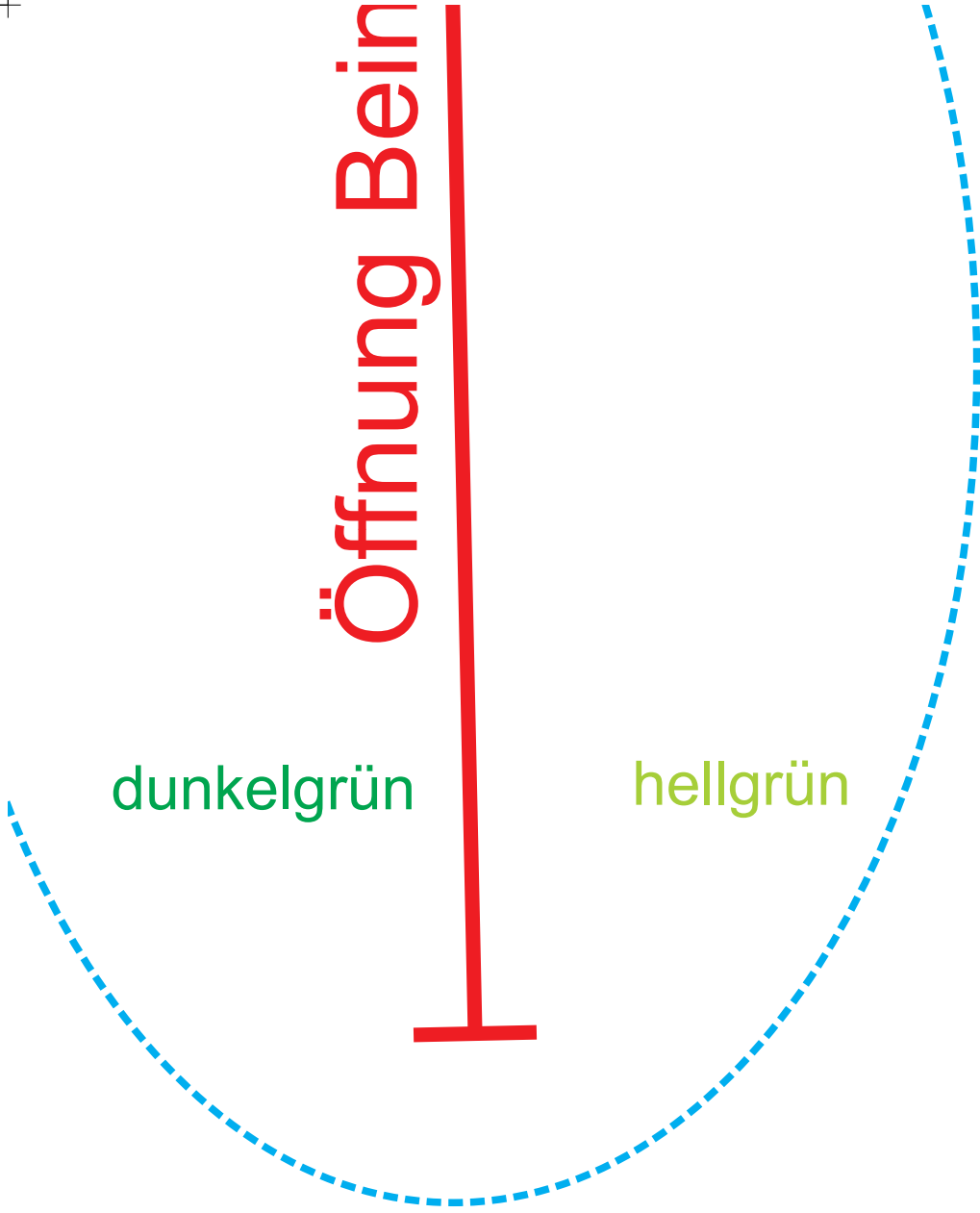





Seitenteil h

---

ellgrün 2x

---

(12, 5)



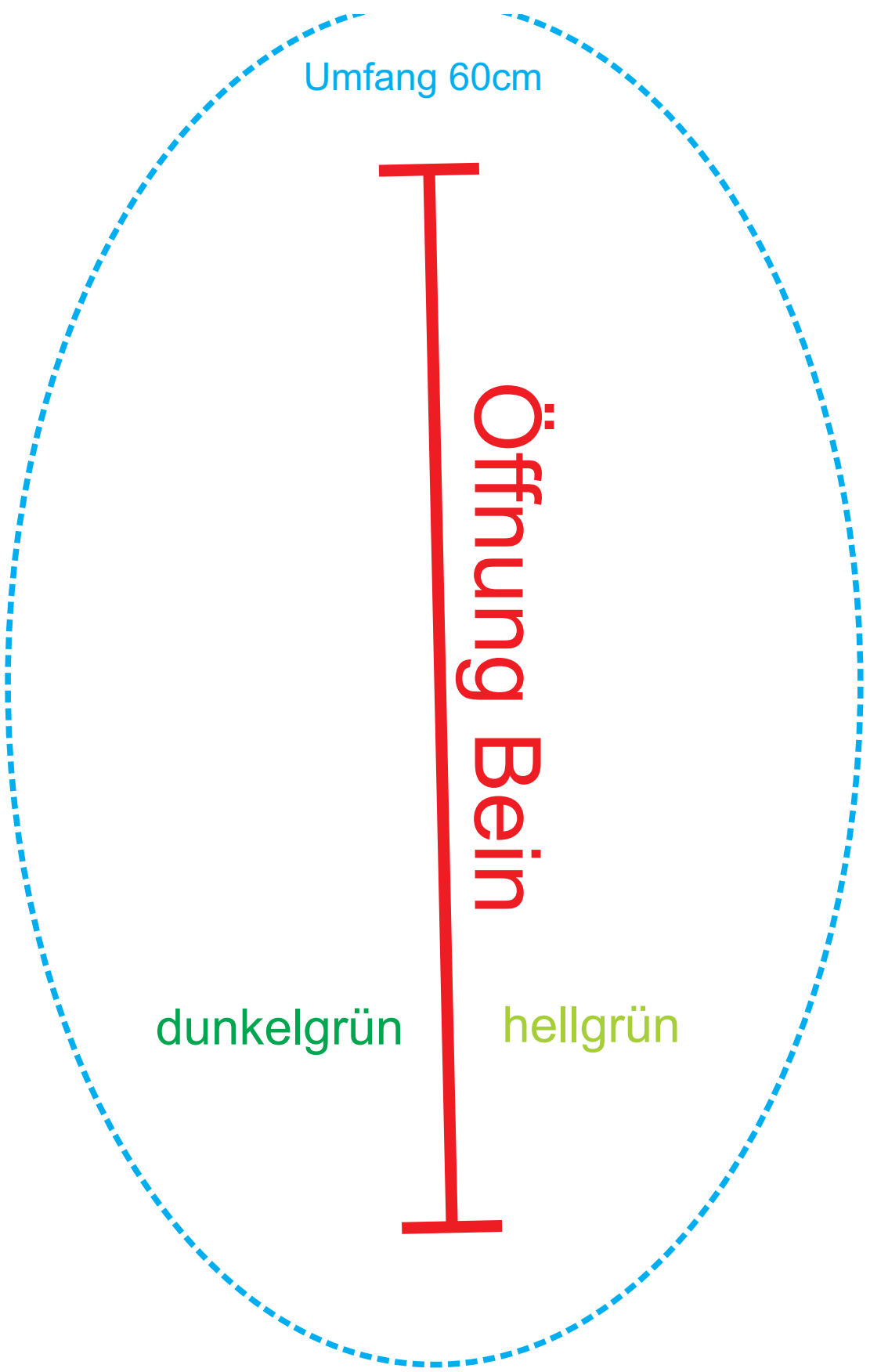

Umfang 60cm

Öffnung Bein

dunkelgrün

hellgrün



Die Nähanleitung und  
Sie dürfen keinen kom  
Eine Gewerbliche Nutz  
Diese Zeichnung unter

die Schablone dürfen Sie  
kommerziellen Nutzen aus de  
zung ist ausdrücklich unte  
rliegt dem Urheberrecht u



für Ihre privaten Zwecke  
er Verwendung dieser Daten  
rsagt.

und Copyright von Bernha

Zeichnungsverfasser



nutzen.  
ei ziehen.

rd Dingwerth (Germany, k

Jan Nelkenbrecher (11.0



(19, 5)

(19.11)

T

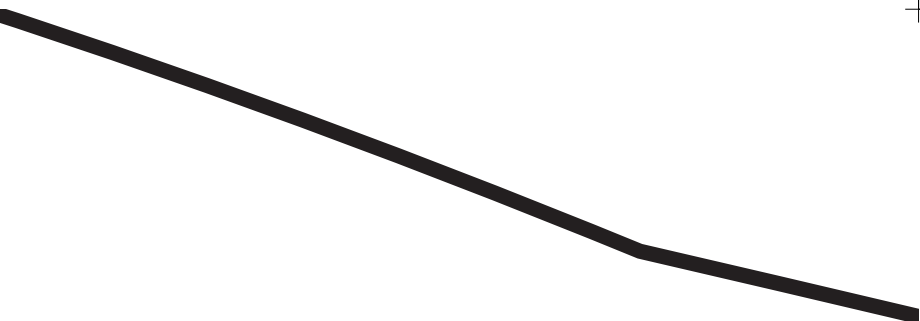

(Kassel)

(09.2011)



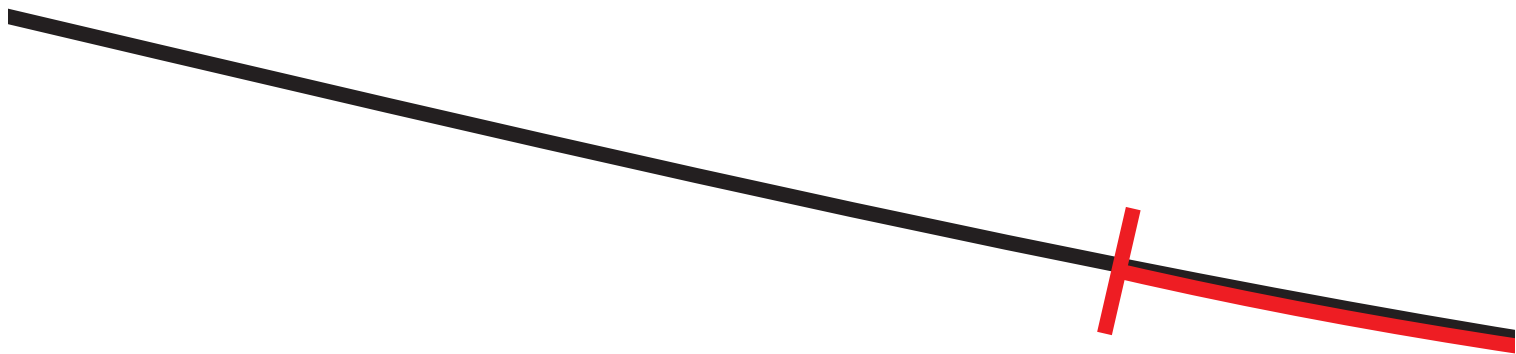

Zacke

~~en einnähen (Nr.12)~~

(22, 5)

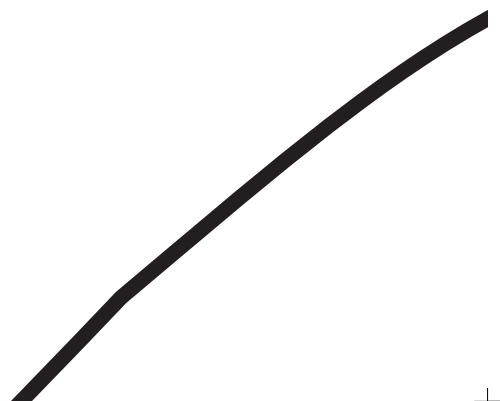
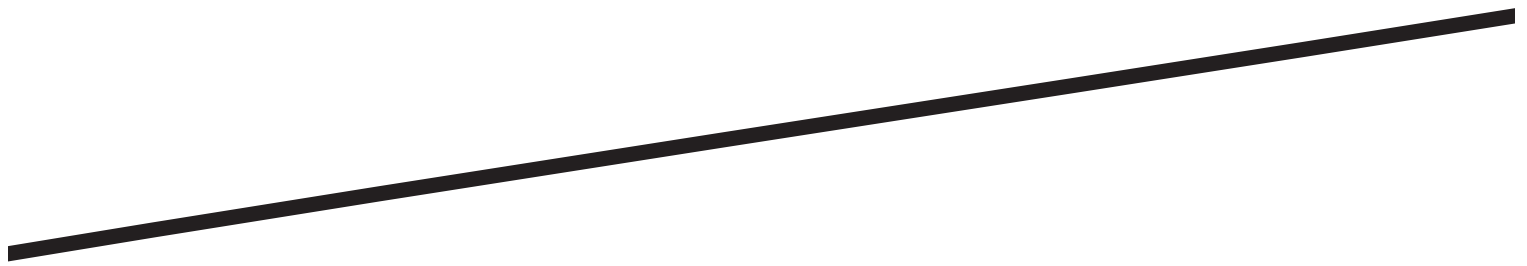
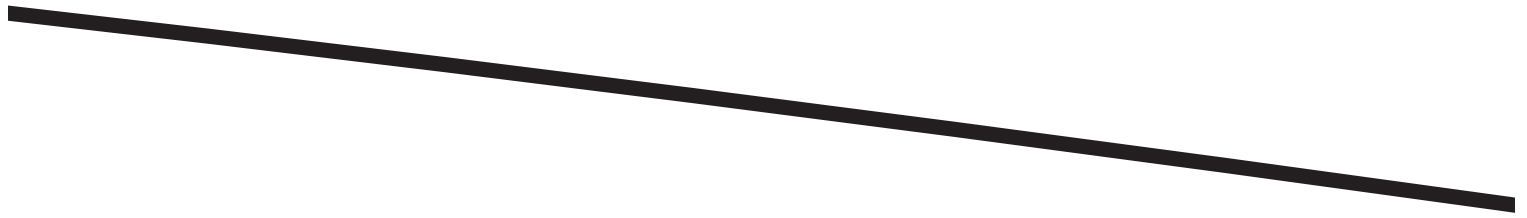
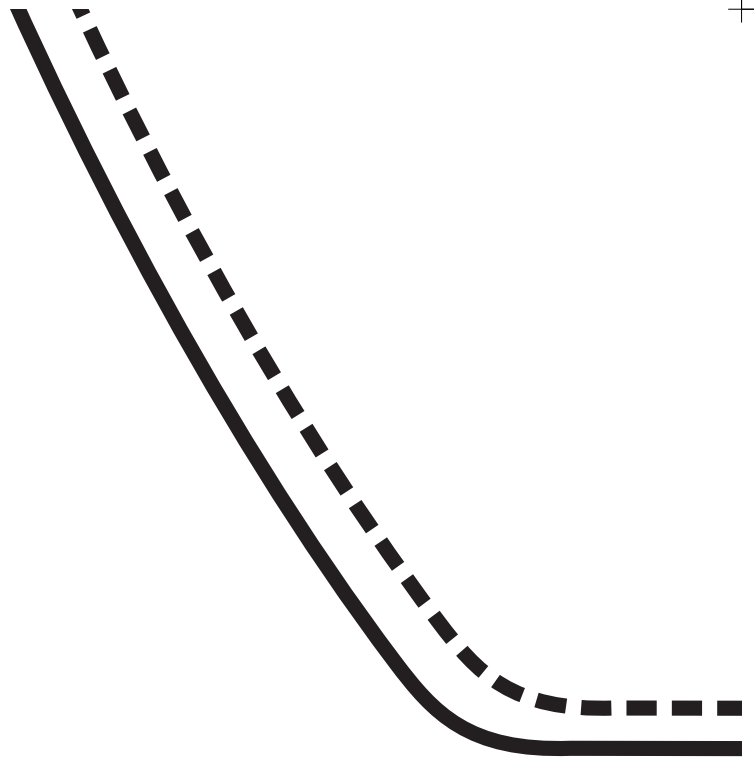

vorn

Ne

E

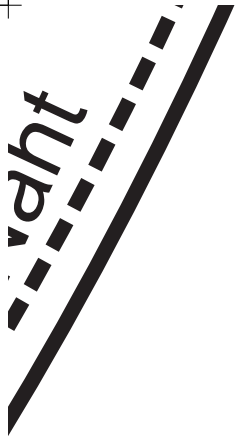





D

D

4

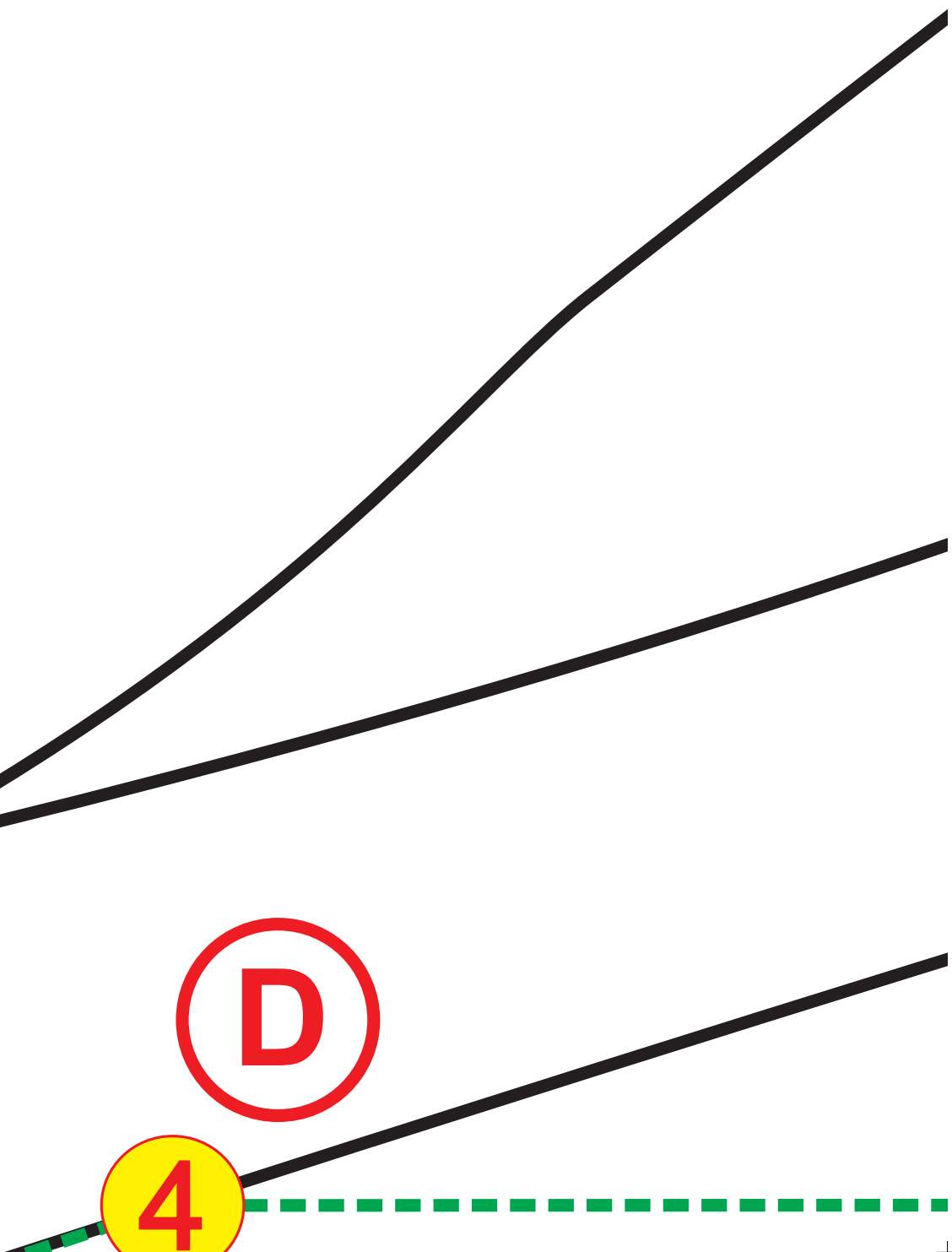

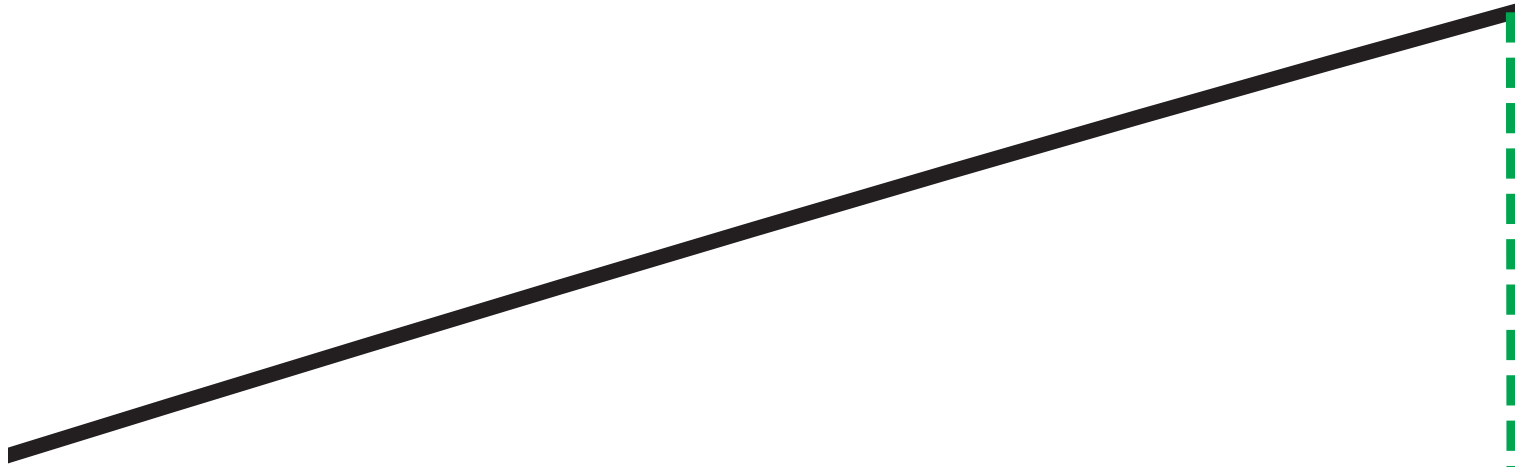
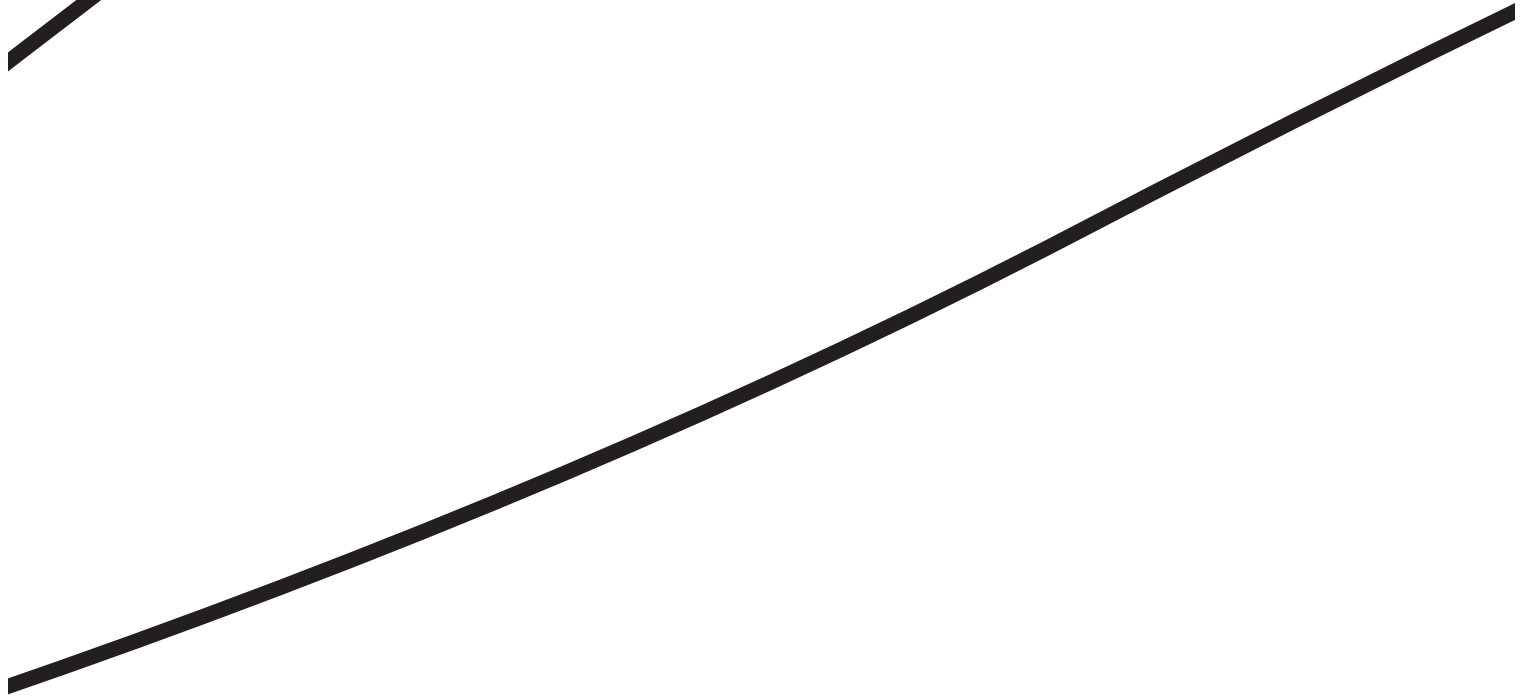
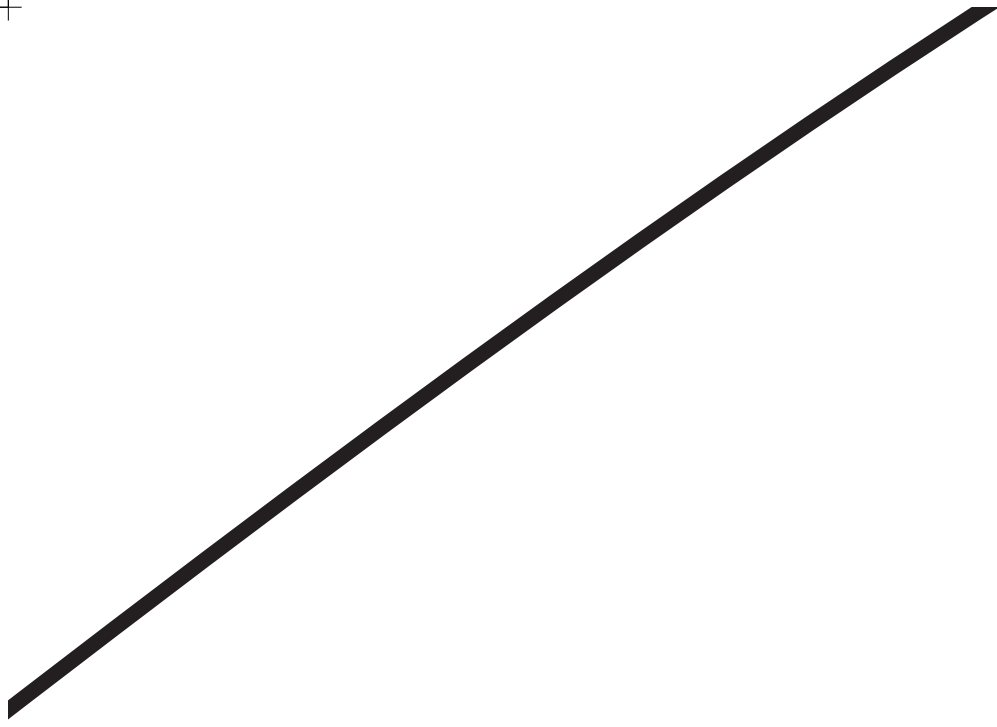

(4, 6)

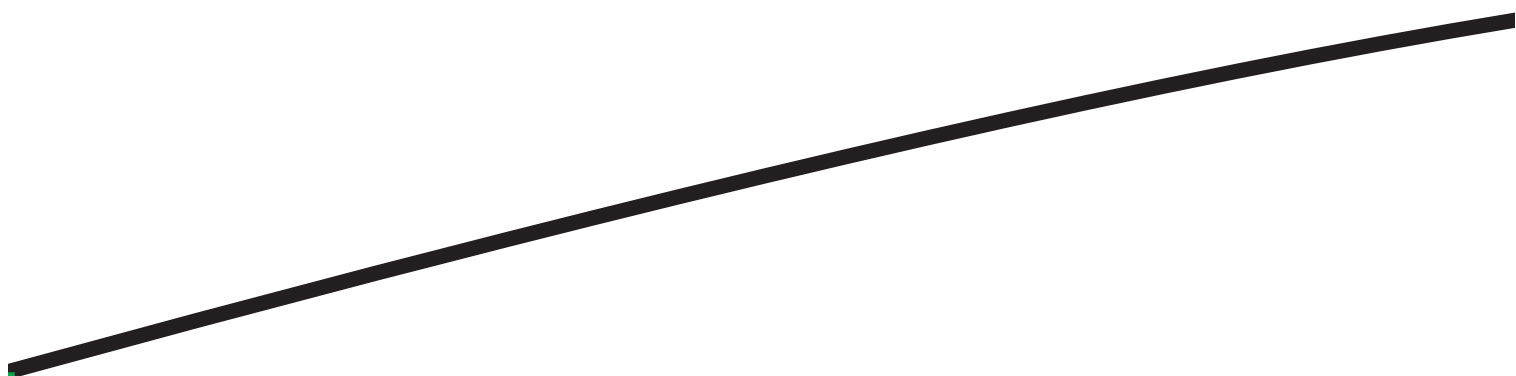
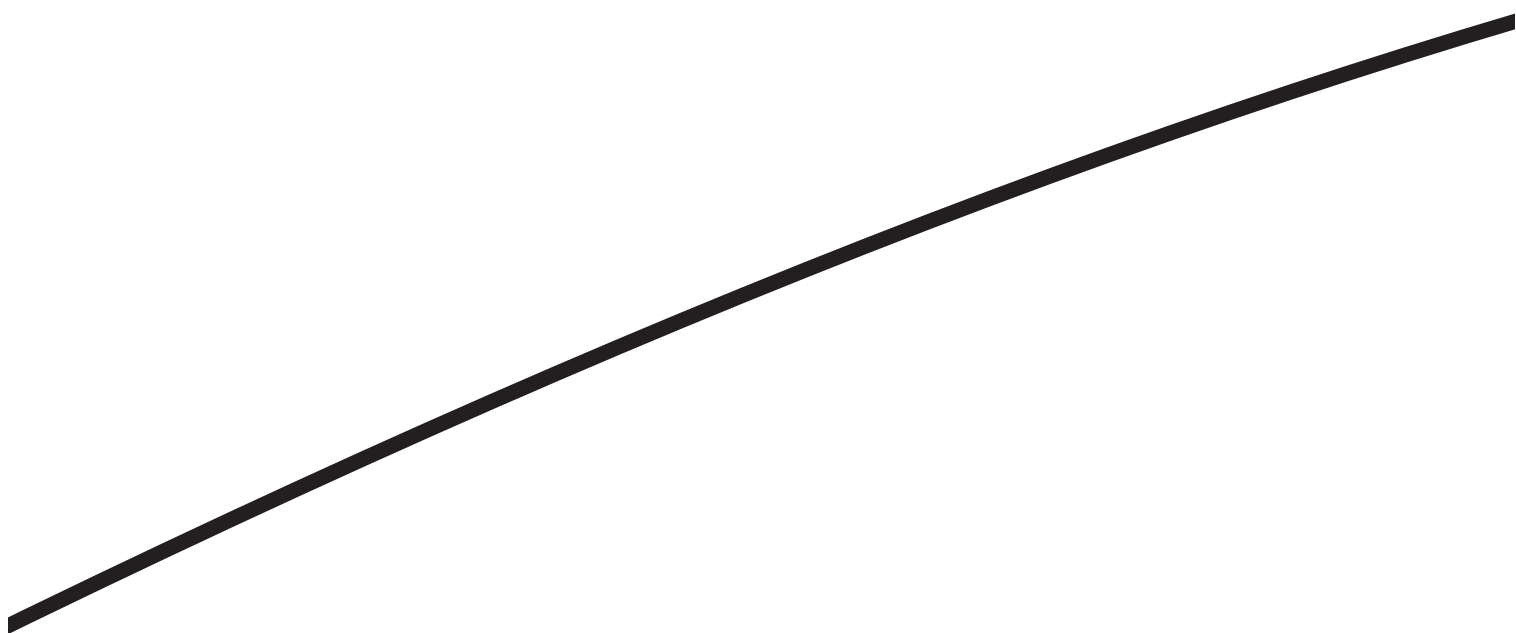

(5, 6)



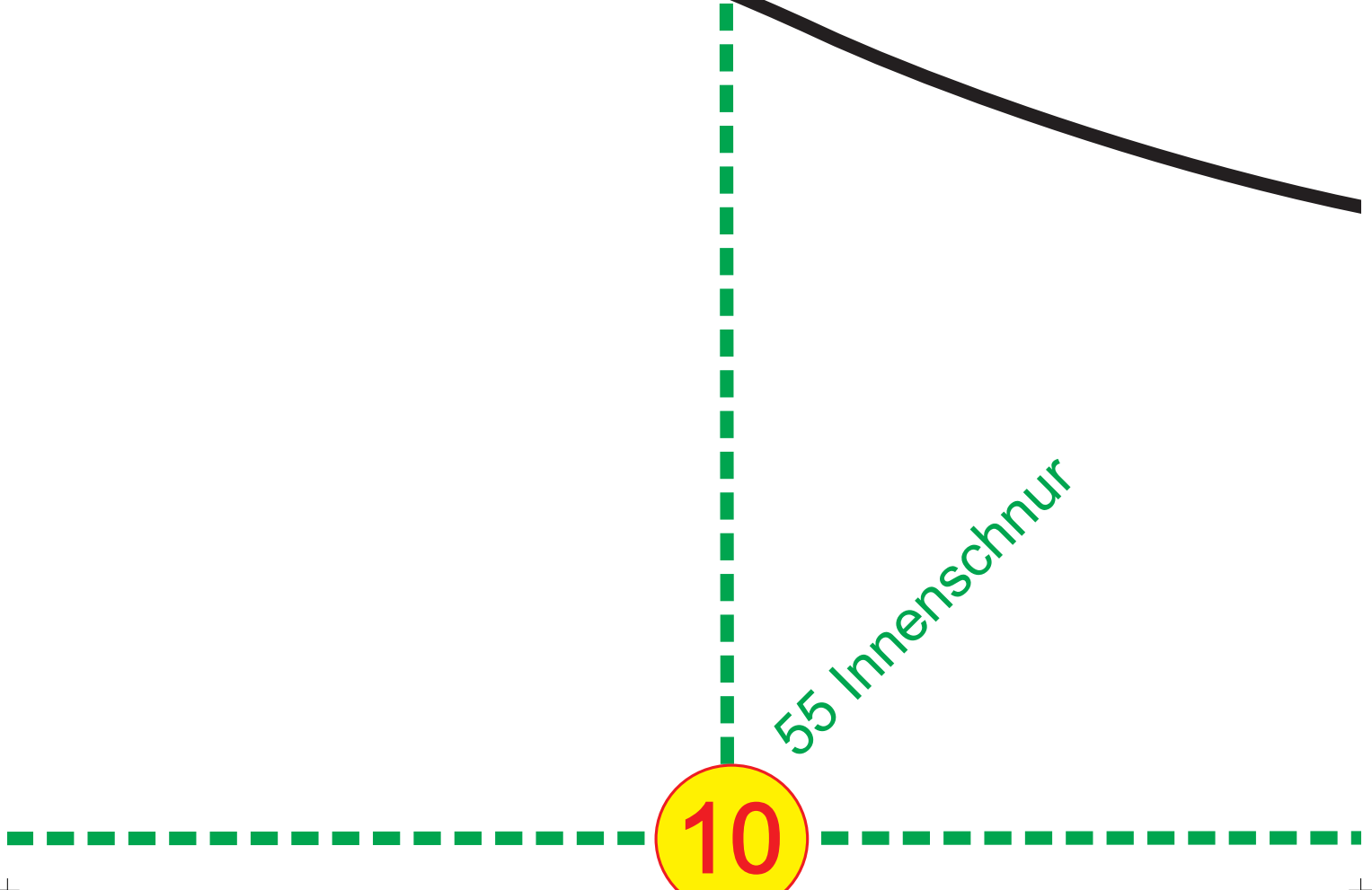
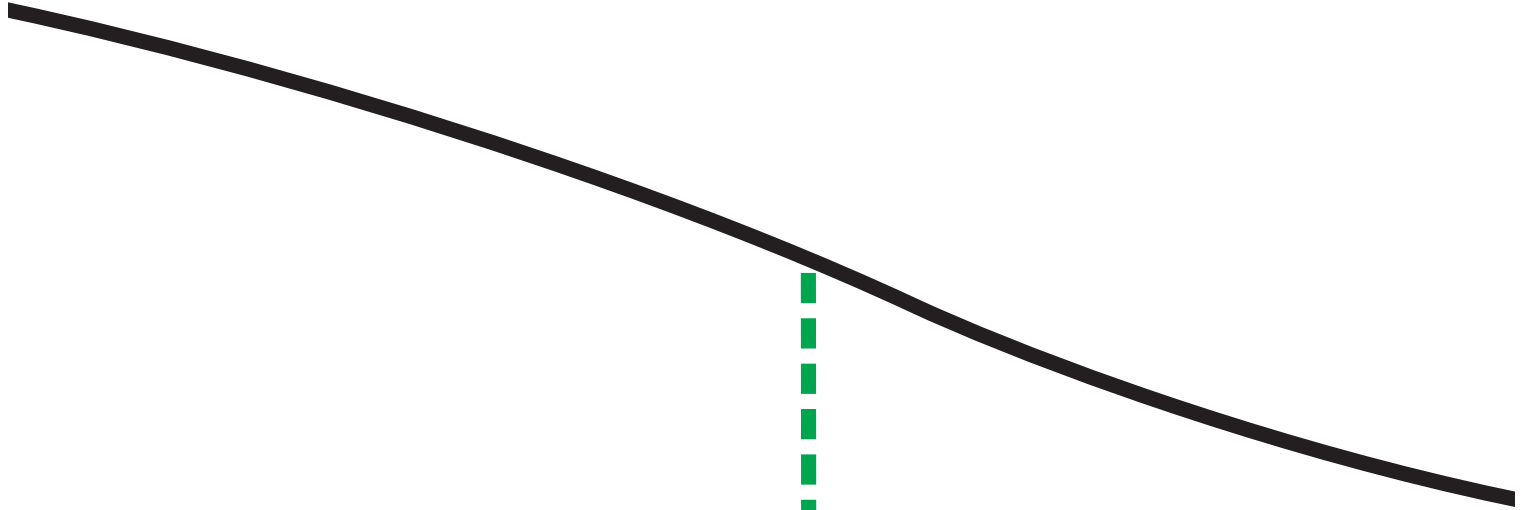

55 Innenschnur

10

(7.6)



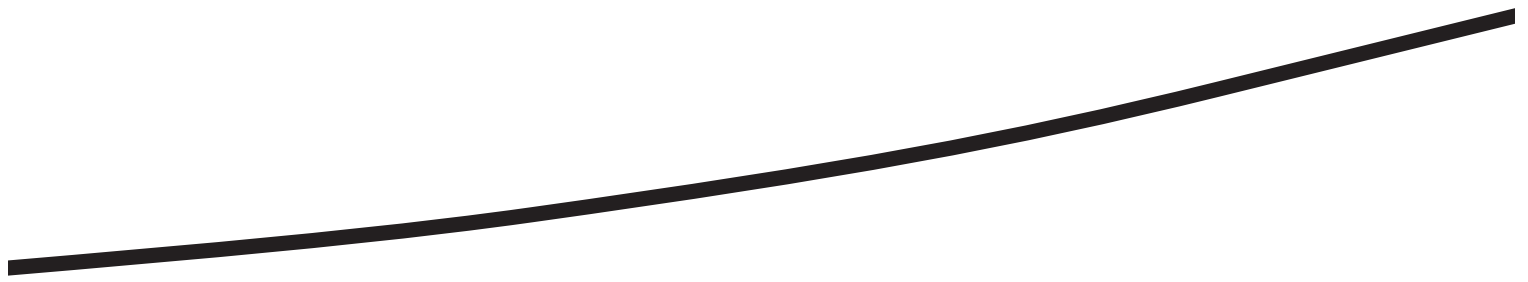





51 Innenschnur

13



(10, 6)



(11, 6)

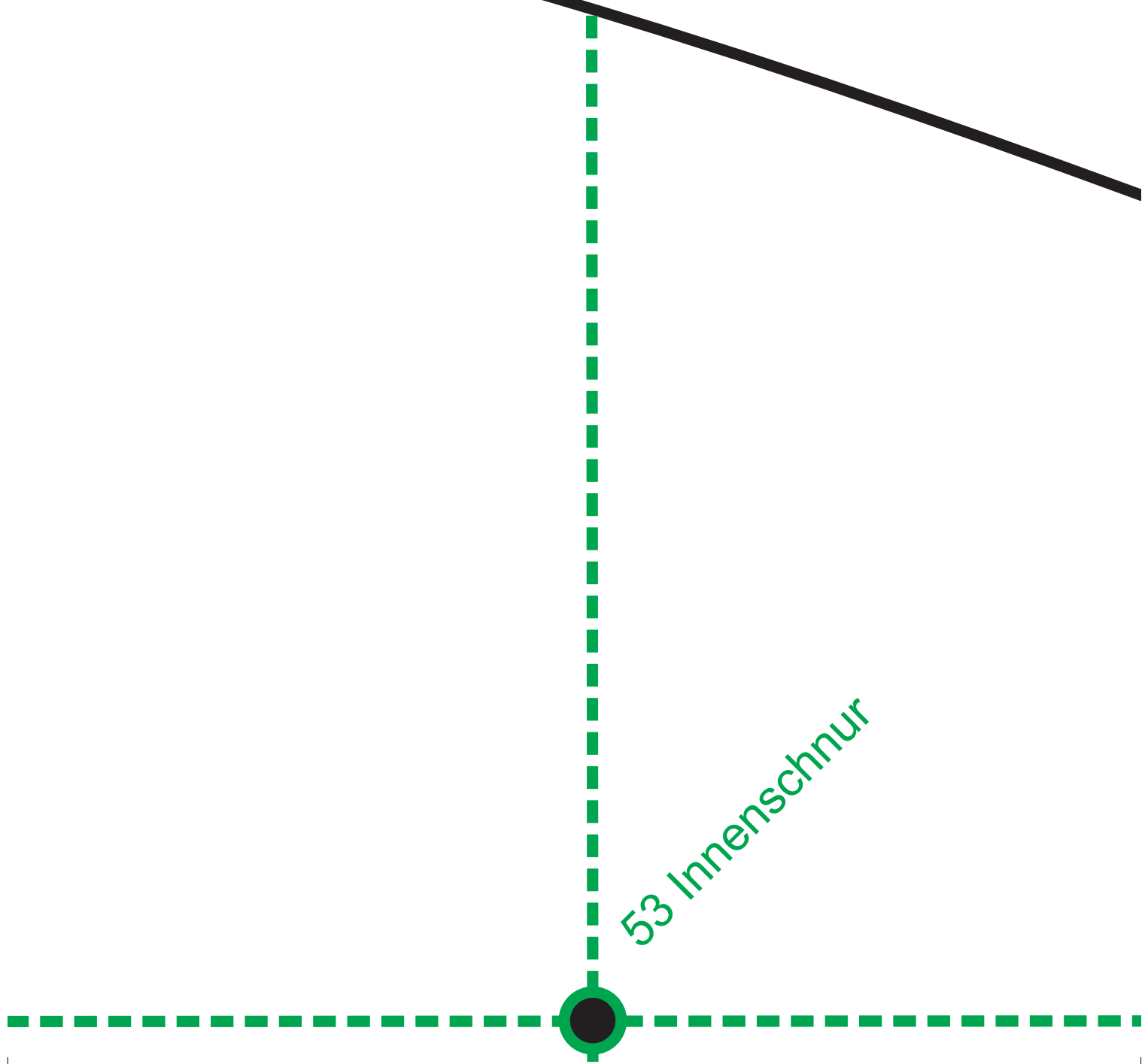
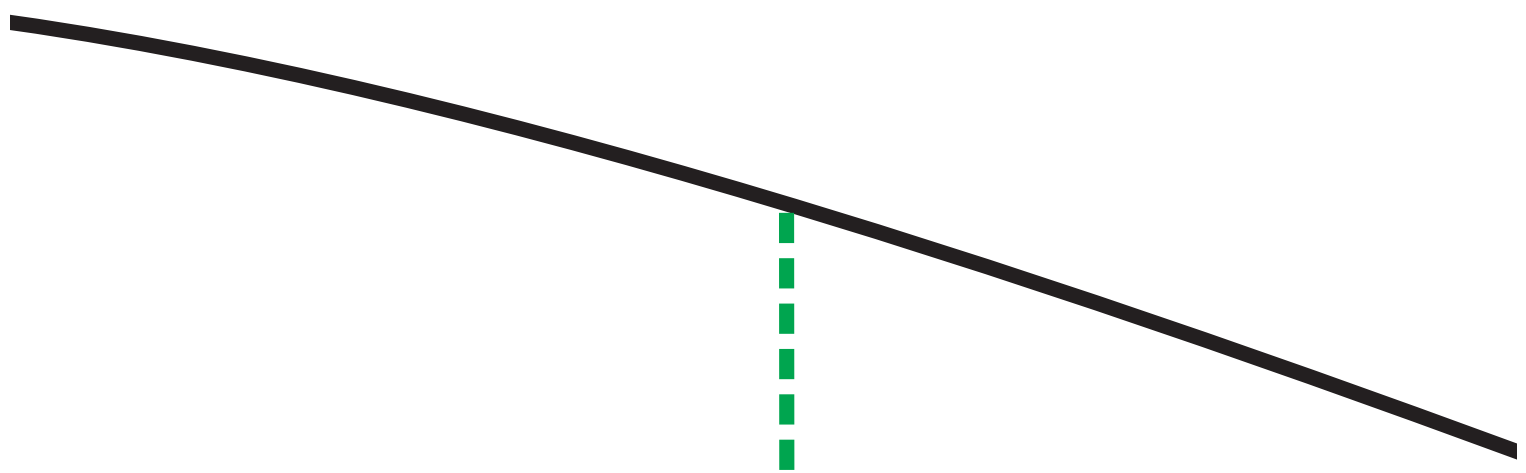

53 Innenschnur

(12, 6)



(13, 6)



(14, 6)

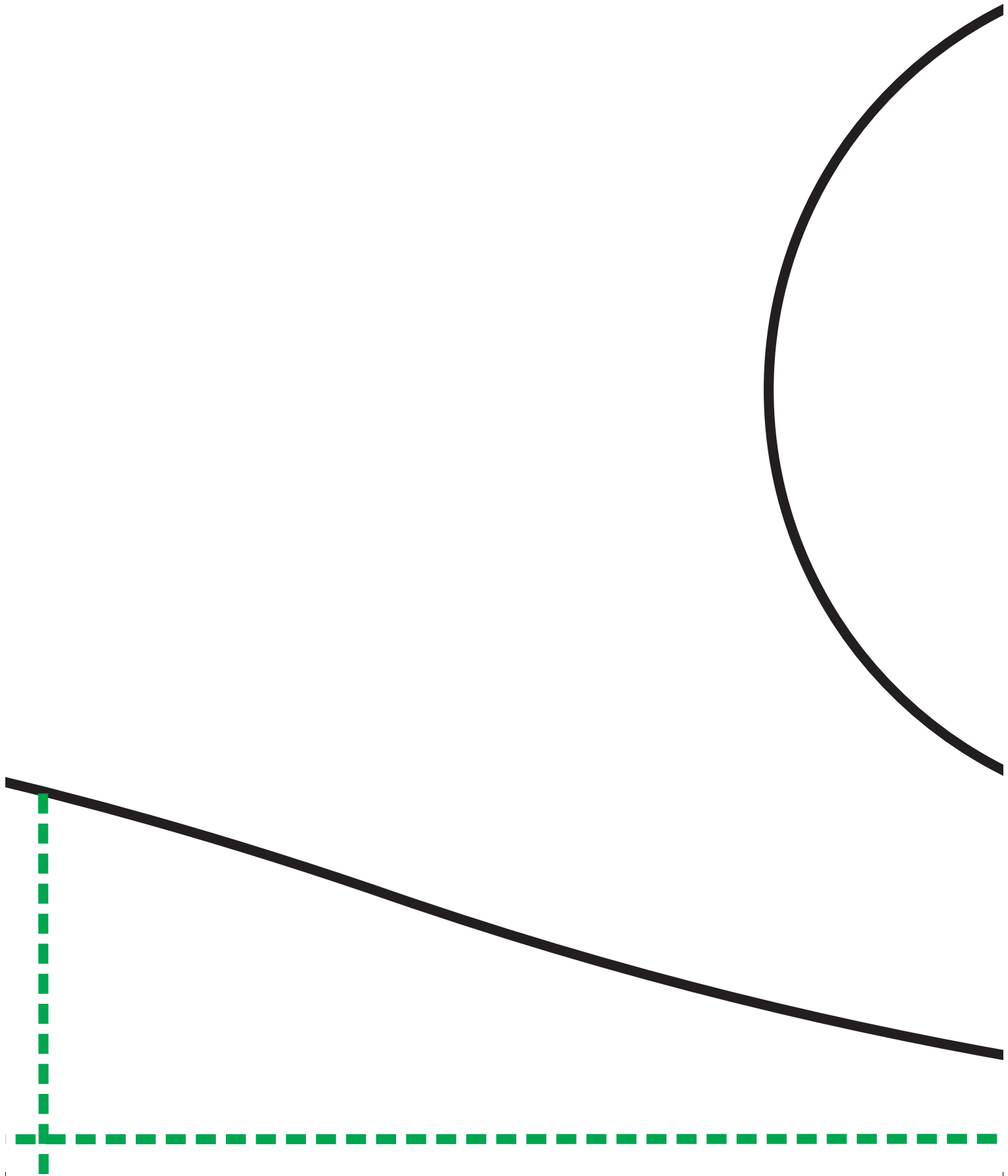

1 x  
Pack-  
sack-  
boden



6 x Sc[





hleppsack

**B**



Liferaufhängung



Nasenloch

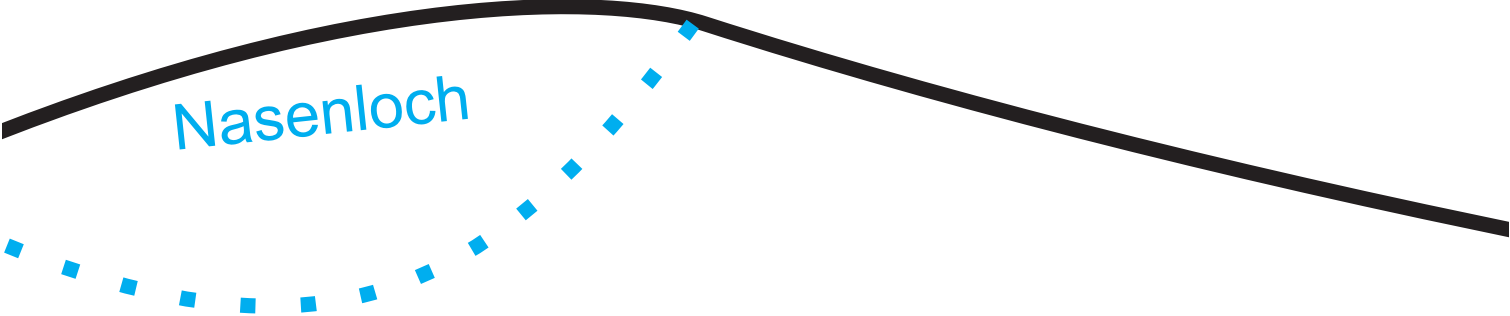





---

seitliches K  
dunkelgrün

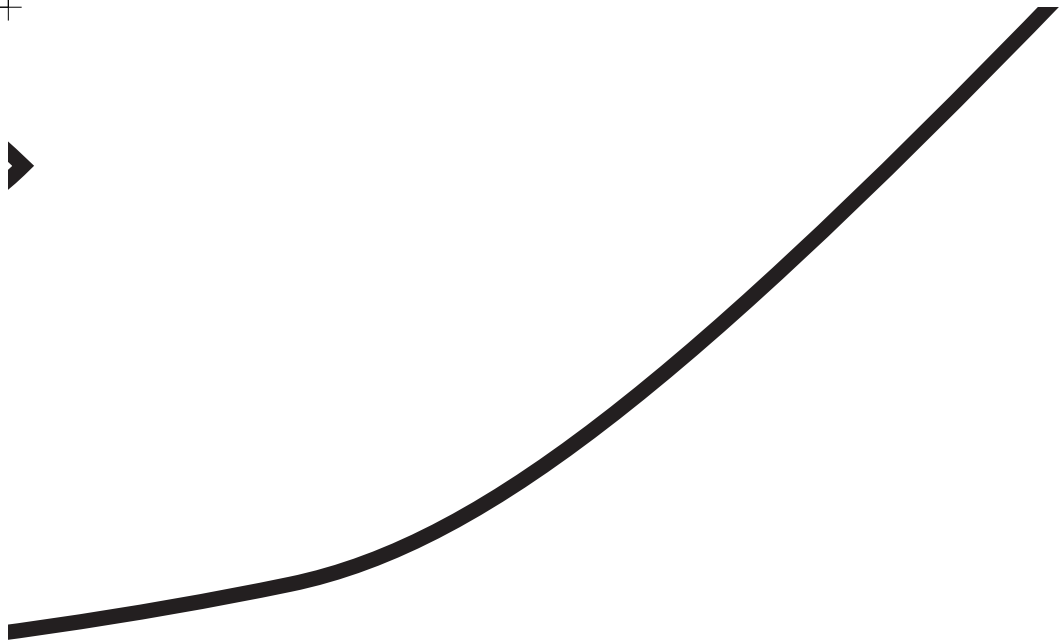

**optteil**

**2x**

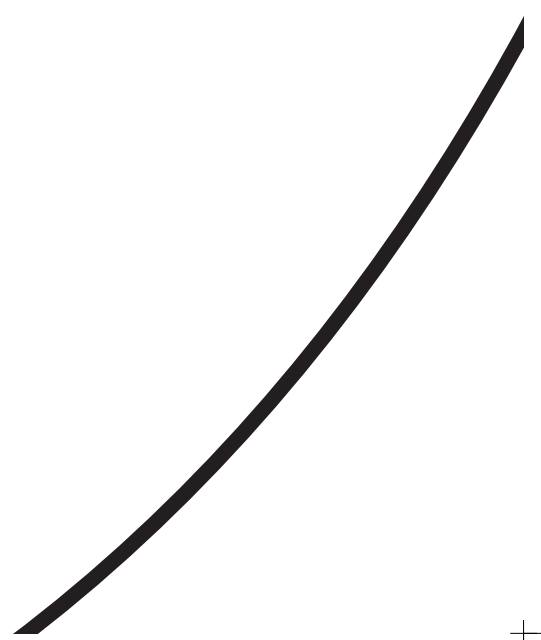

(24, 6)

A



3

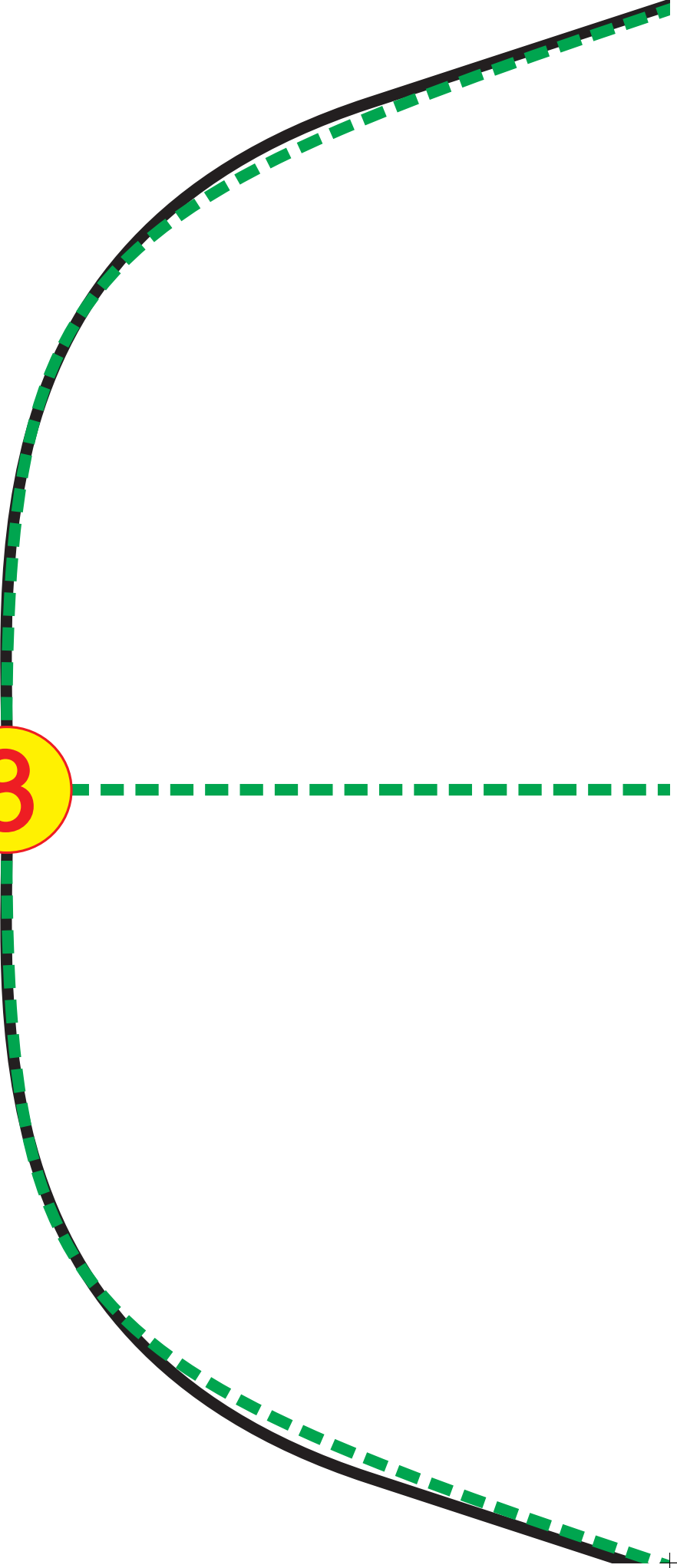

(2, 7)



(3, 7)



45 Innenschnur

(4, 7)

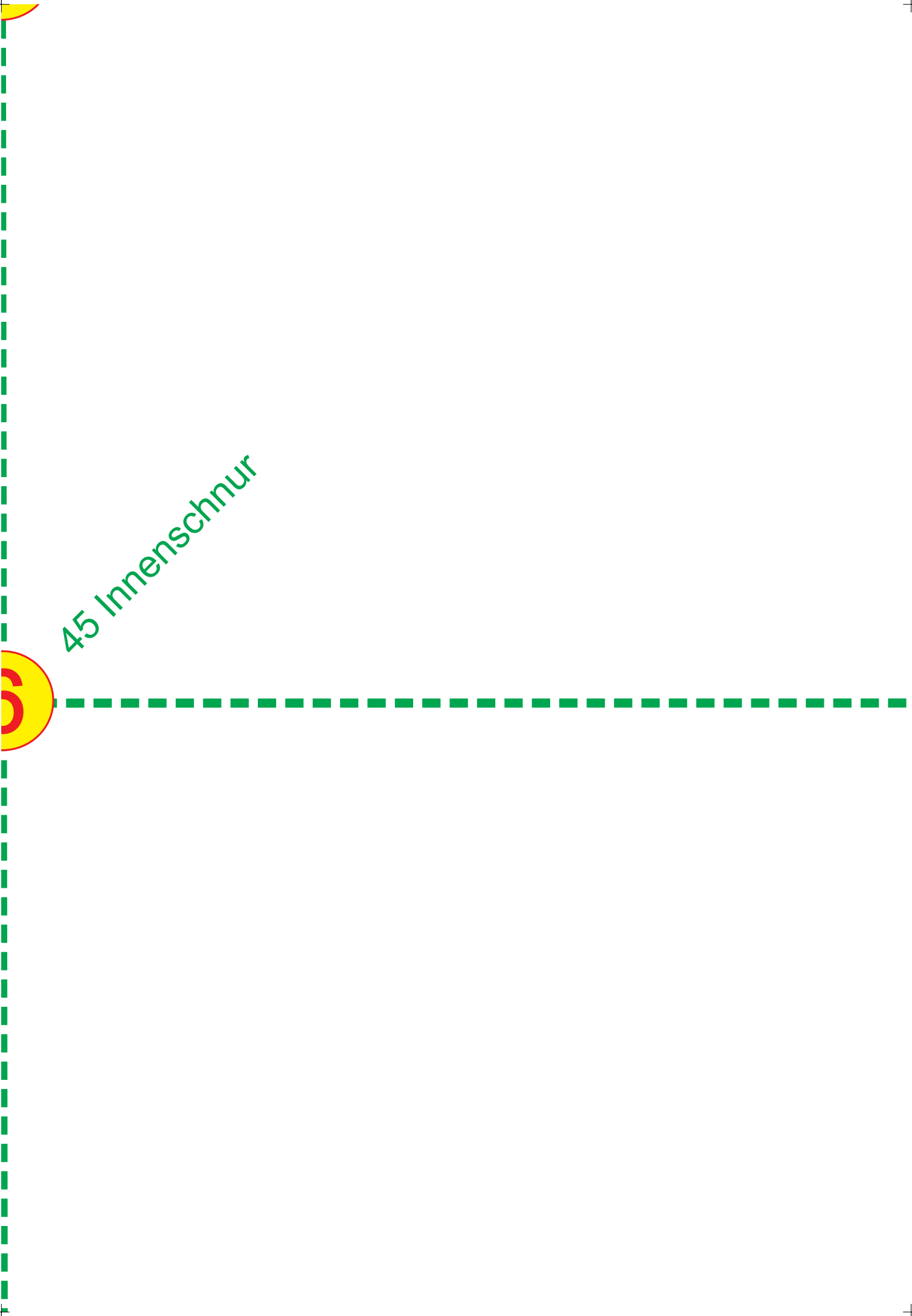



9

55 Innenschnur

Innenschnur





(7, 7)



(8, 7)





(9, 7)



51 Innenschnur

12

Unters

Innenschnur



---

seite gelb 1x

(11, 7)

53 Innenschnur

Innenschnur







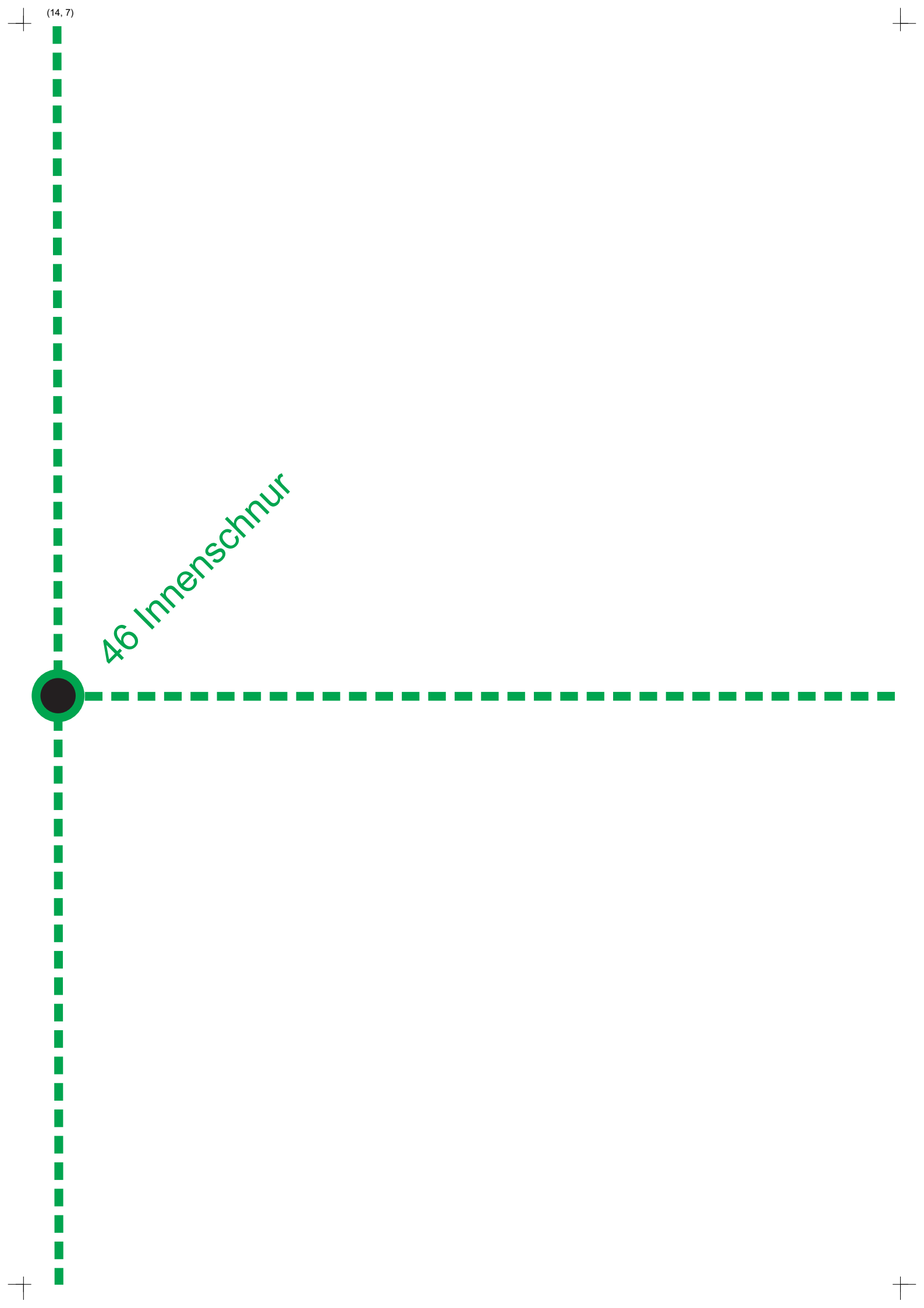

(14, 7)

46 Innenschnur



38 Innenschnur







(17, 7)



(18, 7)



(19, 7)



37 Innenschnur



(20, 7)

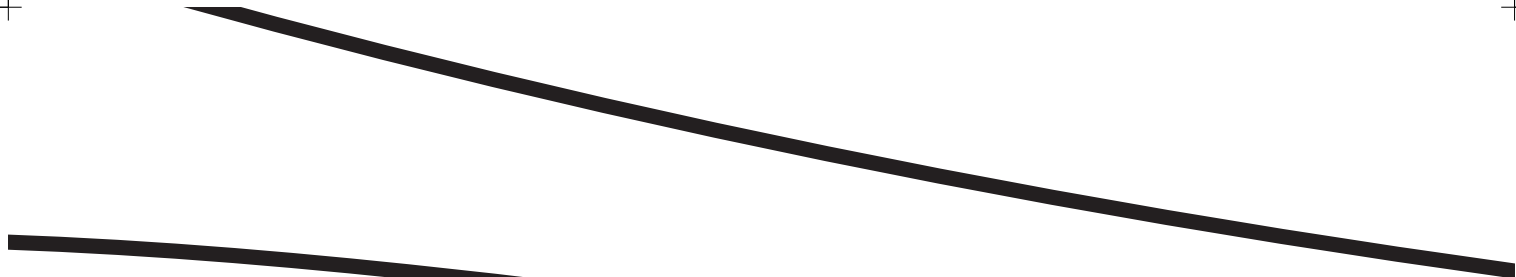

(21, 7)

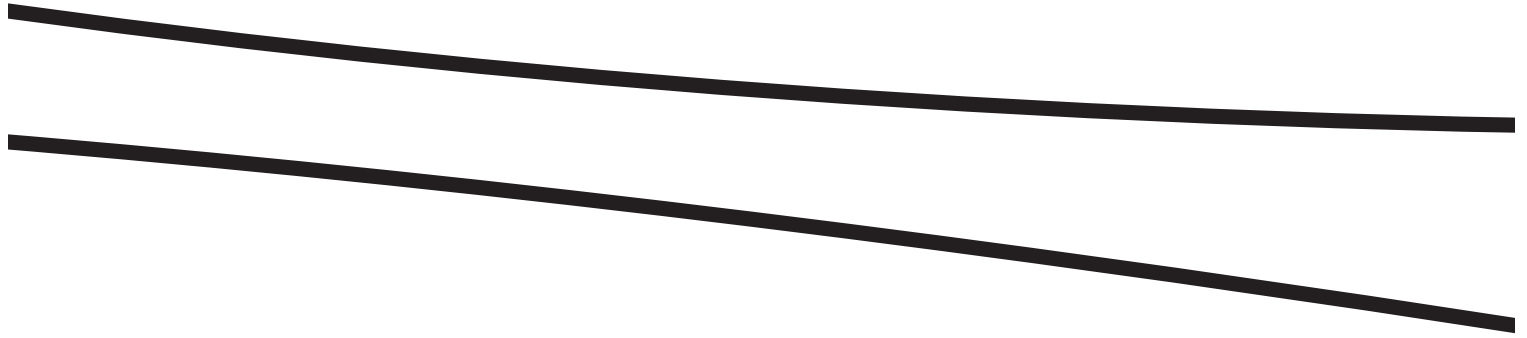



(23, 7)



ⓔ

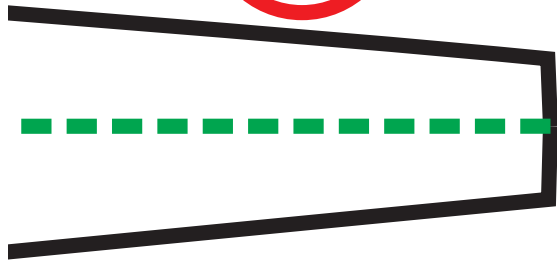



(1.8)



T

(2, 8)



2

D



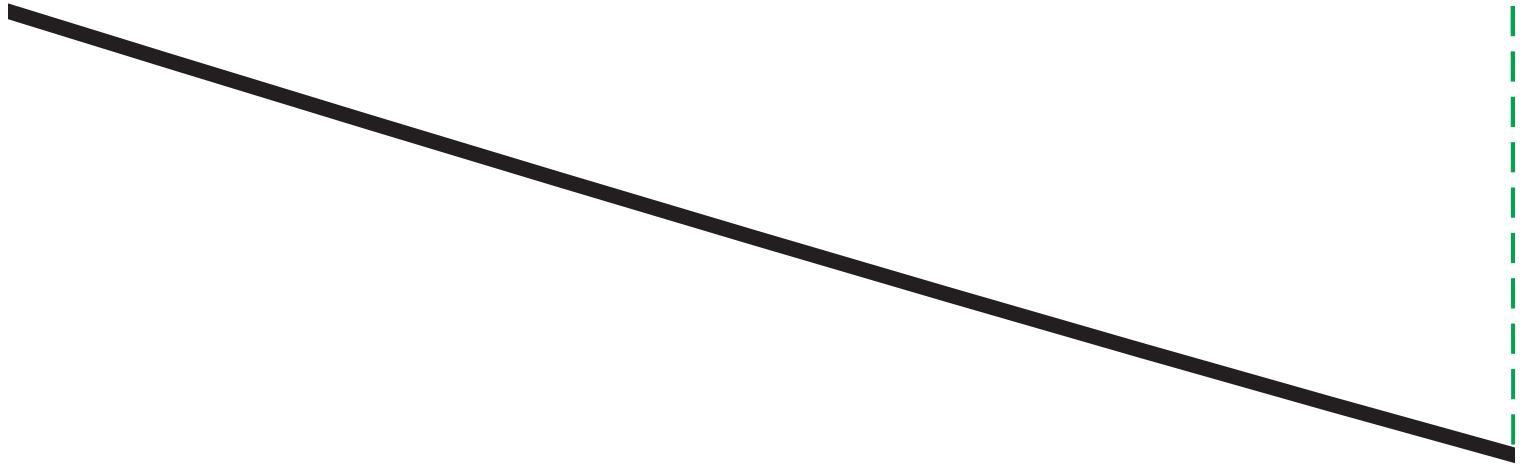

(4, 8)

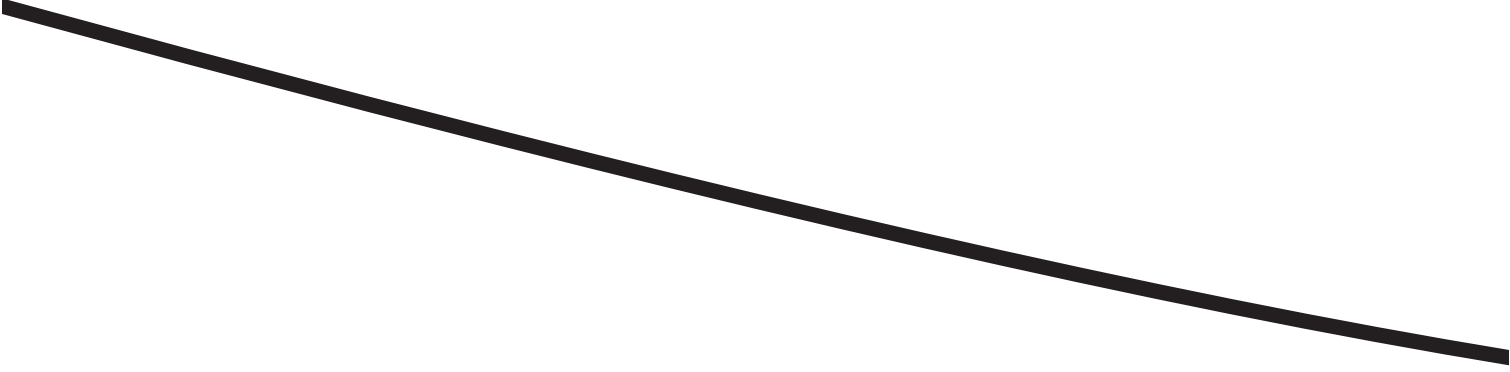



(6, 8)

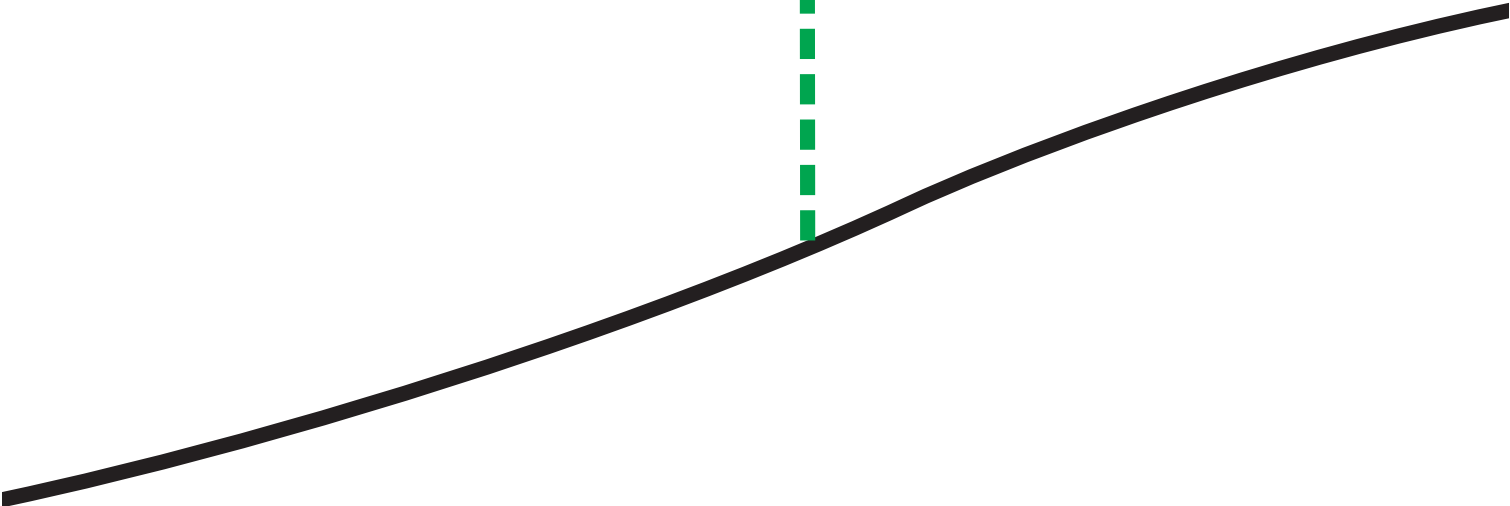
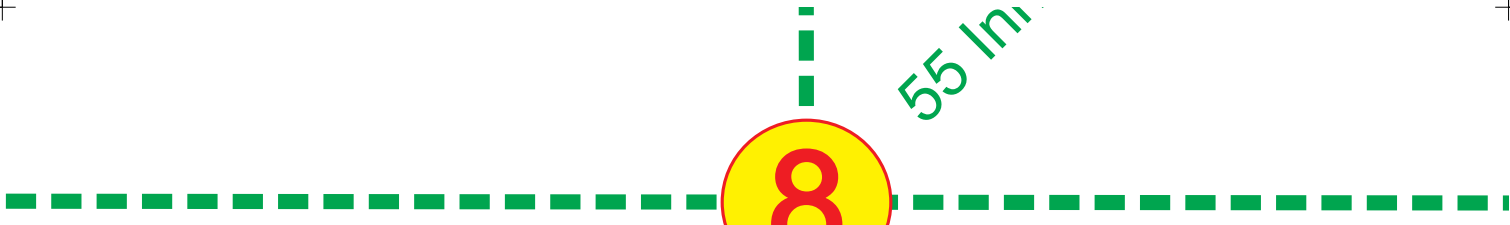

(7, 8)



(8, 8)





(9, 8)

57 Inr.

11

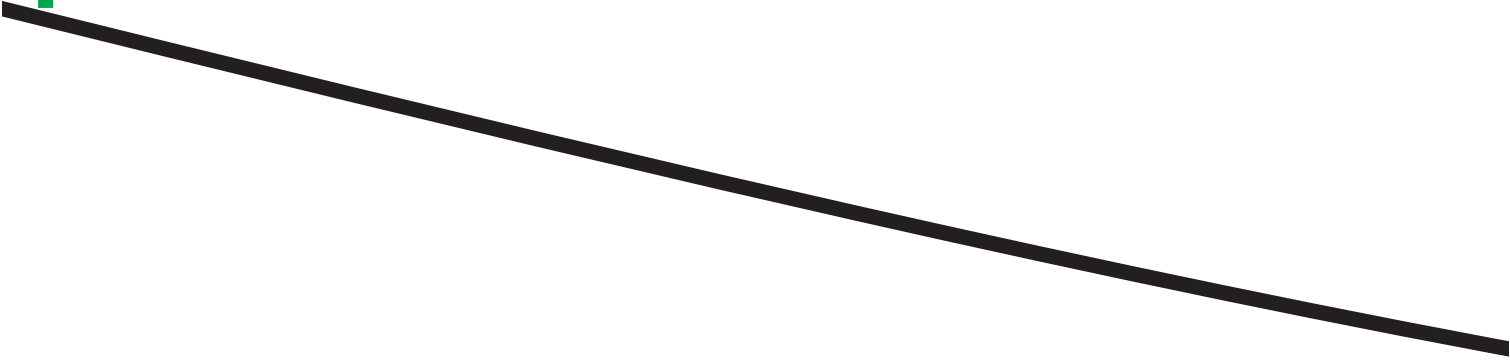

(10, 8)



T

T

(11, 8)

53 In.

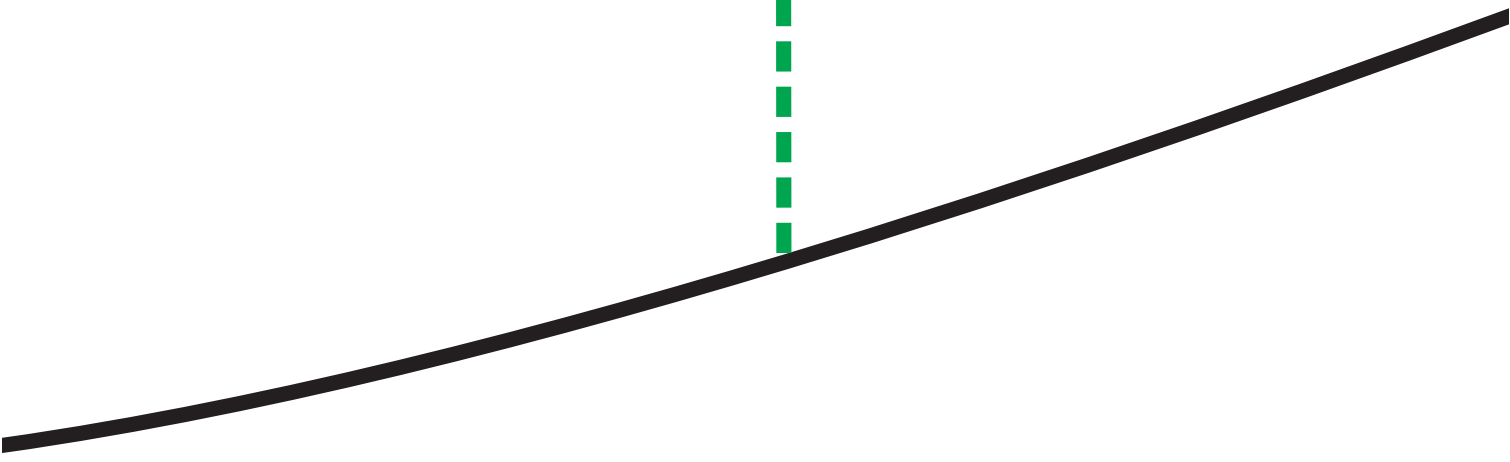

(12, 8)



(13, 8)



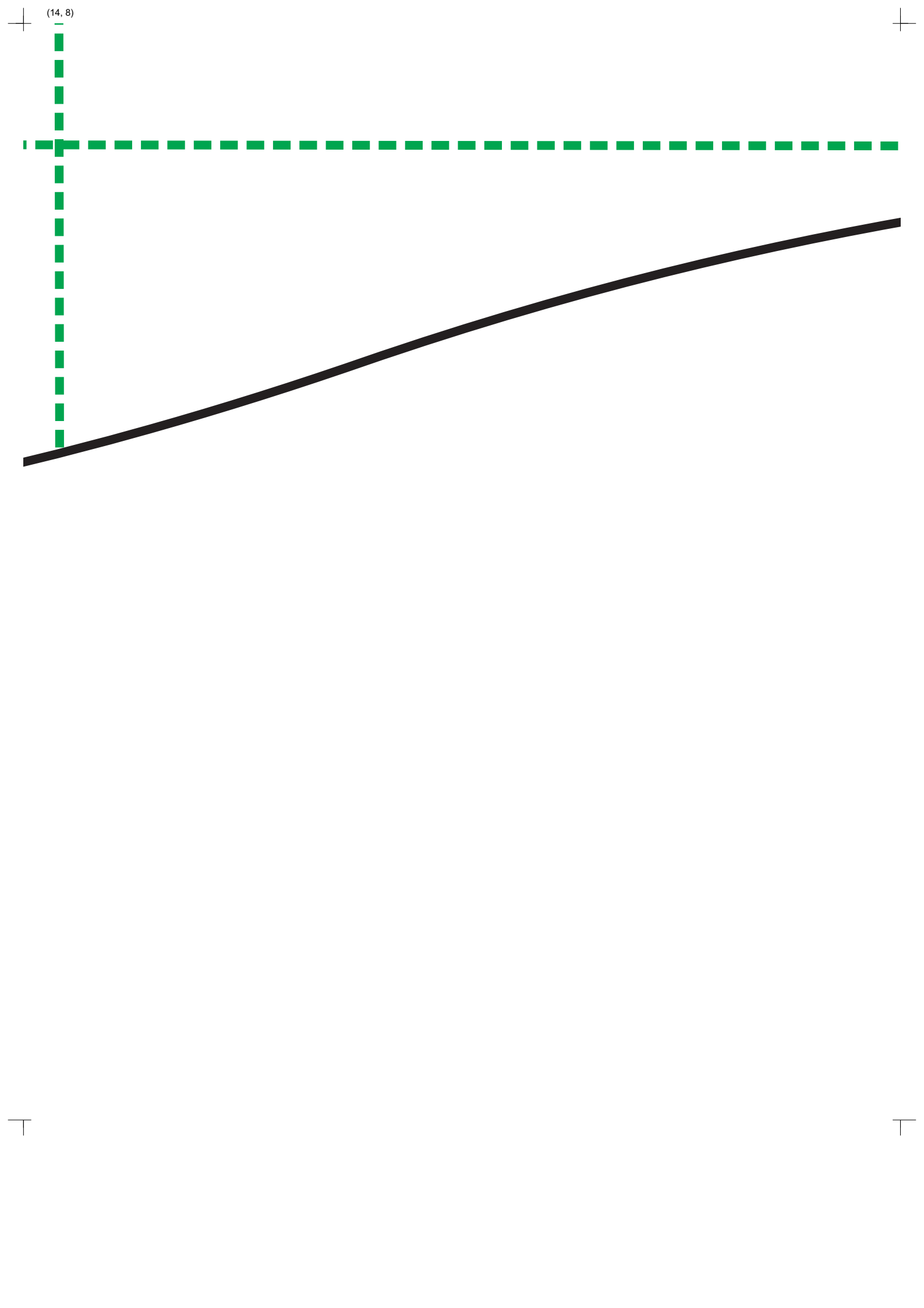

(15, 8)



(15, 8)

(16, 8)



T

T





(18, 8)



(19, 8)



T

T



K

100 cm



100 cm = 1 m



5m



